

2021
INTERIOR
FIT-OUT
EVOLUTION

WOOD
CEILING & COVERINGS
CONTROSOFFITTI
E RIVESTIMENTI
IN LEGNO

RAISED ACCESS FLOORS
METAL CEILINGS & COVERINGS
WOOD CEILINGS & COVERINGS
DEMOUNTABLE PARTITIONS
SUSPENSION SYSTEMS
INTEGRATED AIR CONDITIONING SYSTEMS
OFFICE FURNITURE SYSTEMS

INTERIOR FIT-OUT EVOLUTION

Hi-tech interior products of the new generation.

CBI Europe has produced technological and innovative systems for a complete interior installation, with passion and precision, for thirty-five years, worldwide.

The technical experience and the continuous comparison, with the demands of designers from different markets, make CBI EUROPE an ideal reference point for those who design new, refined and comfortable interiors, and at the same time CBI EUROPE is technologically advanced in an integrated context, offering a very wide range of systems, products, materials, technical solutions and alternatives that improve work environments of the latest generation. We are committed to creating healthy and socially responsible environments. With our continuous research of new materials and systems, the international competition and comparison, awareness of needing to evolve the dynamics of modern construction techniques and to solve traditional problems. CBI Europe says today, these methods; technique, creativity and Italian style promote an interior of the third millennium, worldwide.

**The future is to ensure the quality of the environment
in which we live.**

Prodotti hi-tech per interni di nuova generazione.

CBI Europe produce con passione e precisione sistemi innovativi e tecnologici per l'allestimento completo d'interni, da oltre trentacinque in tutto il mondo.

L'esperienza tecnica maturata e il confronto continuo con le esigenze di progettisti di diversi mercati fanno di CBI EUROPE un riferimento unico ideale per chi progetta interni nuovi, ricercati, confortevoli e al tempo stesso tecnologicamente avanzati in ottica integrata, proponendo una gamma molto ampia di sistemi, prodotti, materiali e soluzioni tecniche alternative e migliorative per ambienti di ultima generazione.

Impegno per la creazione di ambienti sani e socialmente responsabili, ricerca continua di materiali e nuovi sistemi, competizione e confronto internazionale, consapevolezza dell'esigenza di evolvere le dinamiche delle moderne tecniche costruttive per risolvere le problematiche tradizionali sono i metodi con cui CBI Europe, oggi, afferma la tecnica, la creatività e lo stile italiano nel mondo e promuove un'edilizia per interni di terzo millennio.

Il futuro é garantire la qualità degli interni in cui viviamo.



The future is now: CBI Europe integrated solutions for high-quality environments.

**Technological
and innovative
systems
for a complete
interior
installation,
with passion
and precision,
for 35 years,
worldwide.**

Reliable and timely deliveries all around the world
Consegne puntuali e affidabili in tutto il mondo

CBI EUROPE, IN THE HEART OF ITALY

Thanks to its strategic location in central Italy, in the heart of the Mediterranean region, CBI Europe is the ideal partner for Middle Eastern, African, Central and Eastern European customers.

La posizione dell'azienda nel centro Italia, nel cuore della produzione mediterranea, fa di CBI Europe il partner ideale per clienti in Medio Oriente, Africa, Centro e mercati dell'Europa orientale.



auditoriums
theatres
airports
conference rooms
offices
museums
shopping malls
public spaces

**Wood ceilings & coverings:
technology, inspectability,
and freedom of design.**

WOOD is an integrated system of wood suspended ceilings and wall claddings, dedicated to all those who demand a functional but welcoming environment in which to work. WOOD acoustical wall and ceiling systems combine refined elegance with excellent technical and acoustic performance. The WOOD system includes four product families and offers the perfect solution for the complex needs of contemporary architecture and interior design.

WHERE auditoriums, theatres, airports, conference rooms, offices, public spaces and all environments that require effective noise control and elegant interior design.

HOW sound absorbent and fire resistant modular elements with a high technology content, available in a vast range of colours and wood essences.

WHY versatile, safe, acoustically perfect, easy to install and inspect.

**Controsoffitti
e rivestimenti in legno:
design, sicurezza.
fonoassorbenza.**

WOOD è il sistema integrato di controsoffitti e rivestimenti in legno dedicato a chi ama un ambiente di lavoro funzionale ed accogliente, con elevate prestazioni estetiche, tecniche ed acustiche. Articolato in quattro tipologie di prodotto, WOOD è la giusta risposta alle molteplici esigenze architettoniche e progettuali contemporanee.

DOVE auditorium, teatri, aeroporti, conference room, uffici, spazi collettivi e tutti gli ambienti che richiedono elevato controllo del livello di rumore ed interior design ricercato.

COME con elementi modulari fonoassorbenti ed ignifughi ad elevato contenuto tecnologico, in una gamma infinita di cromie e finiture legno.

PERCHÉ versatile, sicuro, acusticamente perfetto, facile da installare ed ispezionabile.

CBI Europe
Wood systems:
safety,
effective
noise control
and elegant
interior
design.



sound absorption

The person at the centre

La persona al centro

Modern, welcoming workplaces, free from noise pollution, where the warmth of natural wood is complemented by stylish, clean lines. Sherwood plain and perforated panels set new standards in style for public offices and community spaces. Perfect acoustics and elegant design create reverberation-free meeting places offering the ultimate acoustic comfort. Without compromising on the elegance and warmth of a wood finish. For a better quality of life and work. The visible perforations and slots form intersections, with nonwoven fabric backing, which provide different and high levels of sound absorption depending on the needs of each environment. They are particularly suitable for auditoriums, theatres, airports, convention centres, conference halls, prestigious offices, hotels, restaurants, and in any environment where sophisticated elegance is combined with a better acoustic performance.

CBI Europe hi-tech solutions for high quality working and living environments, where acoustic comfort generates well-being and high performance.

CBI Europe progetta soluzioni hi-tech per la qualità degli ambienti di lavoro, dove il comfort acustico migliora benessere e performance.

Luoghi di lavoro liberi dall'inquinamento acustico, moderni ed accoglienti, dove il calore del legno s'accosta alla pulizia delle finiture. Pannelli pieni e forati stabiliscono nuovi canoni estetici, negli uffici e negli spazi destinati alle collettività.

Acustica perfetta e design eccellente creano luoghi d'incontro privi di riverberi, dotati di tutti i comfort acustici, senza rinunciare allo stile ed al calore delle finiture in legno: per una miglior qualità del lavoro e della vita.

Le forature e asolature a vista che formano intersezioni con le forature retrostanti garantiscono differenti ed elevati livelli di assorbimento acustico in funzione delle esigenze di ogni ambiente; sono particolarmente adatti ad essere installati in auditorium, teatri, aeroporti, centri congressi e sale conferenza, uffici prestigiosi, hotel, ristoranti e in tutti quegli ambienti dove un interior design esteticamente ricercato si deve combinare ad un elevato controllo acustico.



SHERWOOD · wood concealed 200 system CWI 100% removable with special suspension system CBI Europe
 Larnaka Airport · Cyprus



SHERWOOD REAL VENEER · ROVERE ASIAGO · PERF. F02
Office Biovet · Peshtera, Bulgaria

High quality environments, where acoustic comfort generates well-being and high performance.

WOOD SYSTEMS



Sherwood



Acoustik Plus



Sound Wood



Lamella



Special Panels



SHERWOOD REAL VENEER
Office Biovet · Peshtera, Bulgaria

WOOD CEILINGS & COVERINGS **SHERWOOD**

Welcome, warmth, design *Accoglienza, calore, design*

Sherwood is CBI Europe's basic line, fire resistant MDF panels and strips, thickness 14 mm.

Versions available:

Sherwood Real Veneer: panels with a natural wood finish

Sherwood Melamine: panels with a melamine finish

Sherwood panels and strips come in plain, perforated and slotted versions, with nonwoven fabric backing.

Sound absorption properties vary according to the type of perforation. Sherwood panels can be installed in suspended ceilings and wall claddings using a variety of mounting systems. Suspended ceilings can use open or closed grids.

Sherwood è la linea basic di CBI Europe composta da pannelli e doghe in MDF ignifugo, spessore 14 mm.

Disponibile in versione:

***Sherwood Real Veneer:** pannelli con finitura legno naturale*

***Sherwood Melamine:** pannelli con finitura melaminico*

Pannelli e doghe sono realizzati nelle versioni liscia, forata o asolata, con tessuto non tessuto fonoassorbente applicato sul retro, e differenti proprietà fonoassorbenti a seconda della foratura. Possono essere installati a soffitto o a parete, seguendo diversi schemi di montaggio. I controsoffitti sono montati con orditura a vista oppure nascosta.



FIRE RESISTANCE
RESISTENZA
AL FUOCO



POINTS LEED CERTIFICATION
PUNTEGGIO LEED



ACOUSTIC ABSORPTION
FONOASSORBENZA



INSPECTABLE
ISPEZIONABILE



ANTI-SEISMIC
ANTI SISMICO



QUICK INSTALLATION
INSTALLAZIONE RAPIDA



FSC WOOD CERTIFIED
LEGNO CERTIFICATO FSC



EXTENDED WORKING LIFE
DURABILITÀ

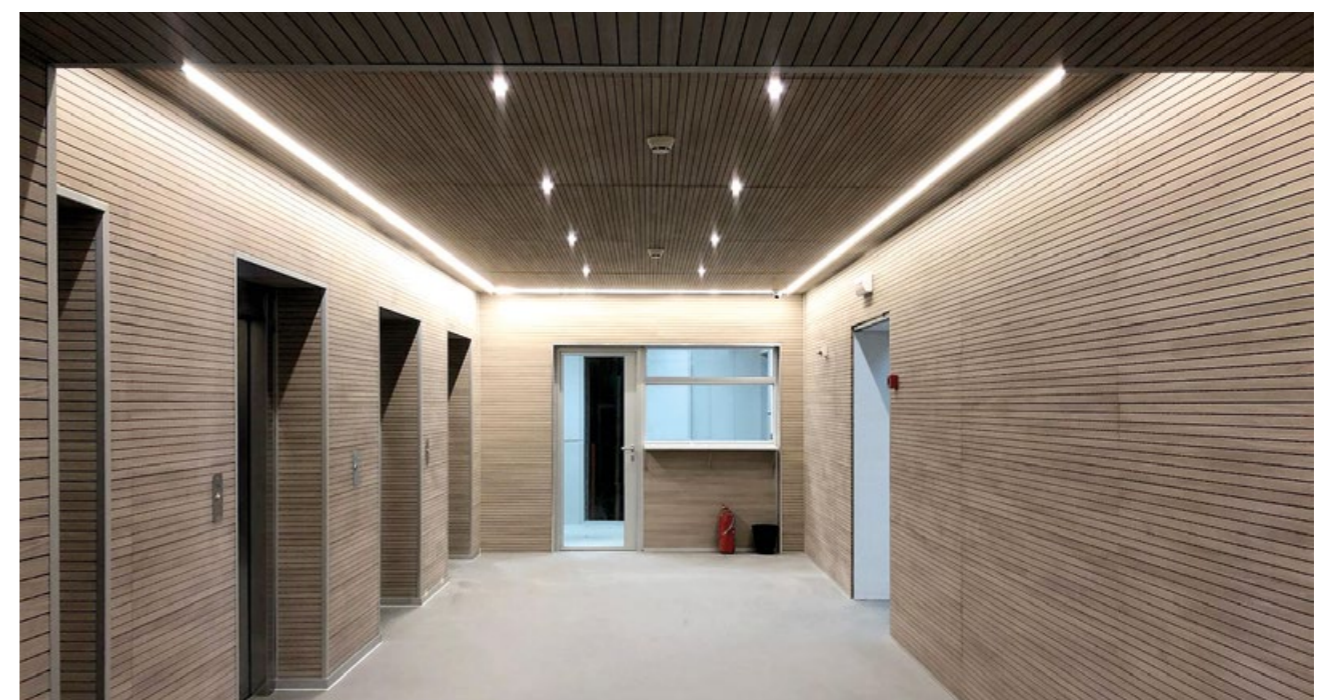



SHERWOOD REAL VENEER
Officine Garibaldi - Pisa, Italy

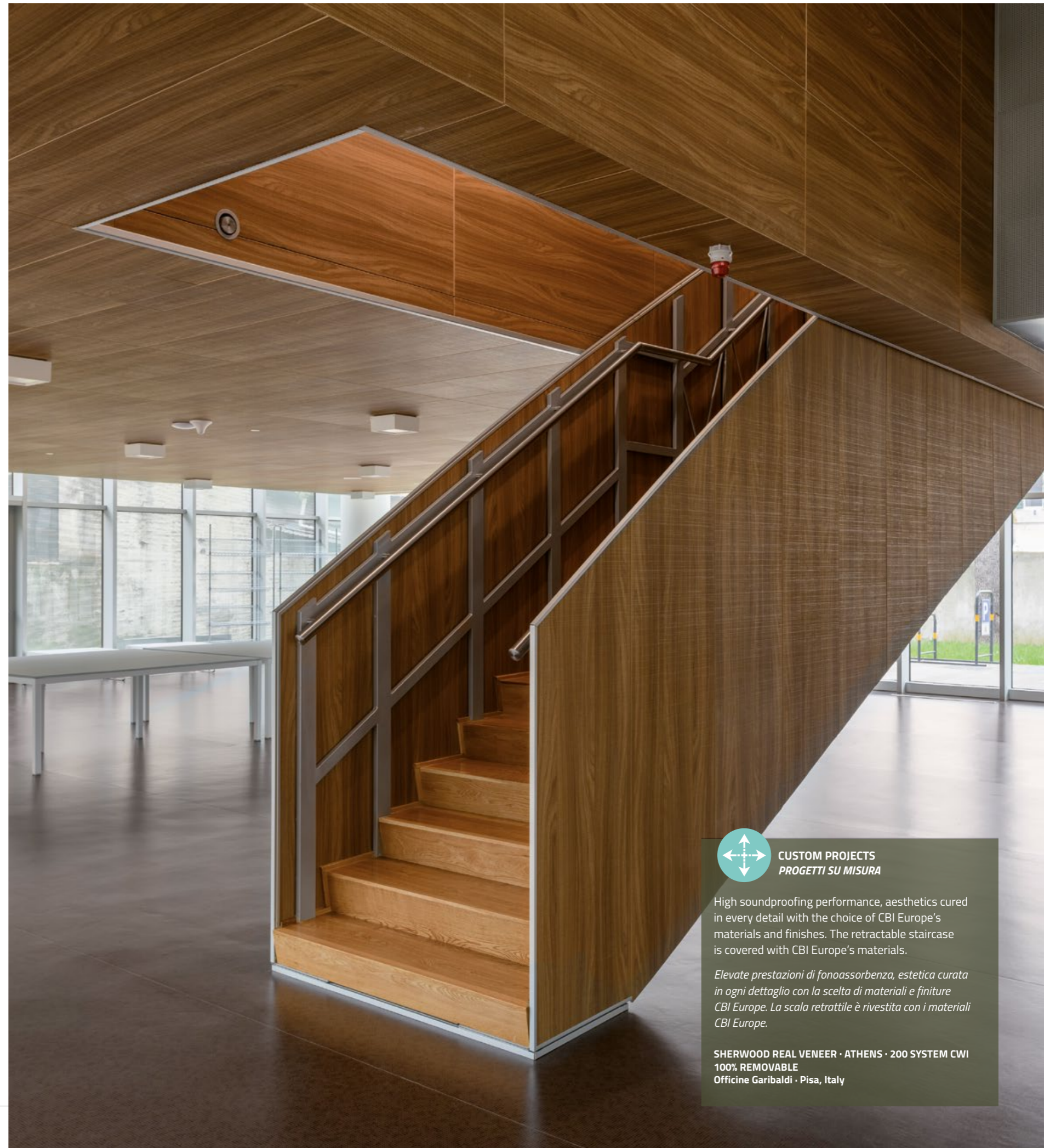

**CUSTOM PROJECTS
PROGETTI SU MISURA**

High soundproofing performance, aesthetics cured in every detail with the choice of CBI Europe's materials and finishes. The retractable staircase is covered with CBI Europe's materials.

Elevate prestazioni di fonoassorbimento, estetica curata in ogni dettaglio con la scelta di materiali e finiture CBI Europe. La scala retrattile è rivestita con i materiali CBI Europe.

**SHERWOOD REAL VENEER · ATHENS · 200 SYSTEM CWI
100% REMOVABLE
Officine Garibaldi · Pisa, Italy**



SHERWOOD PANELS > MAPLE
ceilings: 400 system · coverings: 501 system
Nuovo Auditorium · Camposanpiero, Padova, Italy





**Acoustik Plus,
the elegance of real wood
with a Hi-Tech heart.
Perfect acoustics
and certified safety.**



**FIRE RESISTANCE
RESISTENZA AL FUOCO**

The plaster fibreboard core offers A1 class fire resistance according to the latest Italian standards, while the wood face veneer and backing are treated with special fire resistant paints that are guaranteed by their manufacturers. The result is sheer excellence.

L'anima in gesso/fibre di legno è in classe A1 - DM 10/04/2005; il rivestimento in legno, sia a vista che sul retro, è trattato con vernici intumescenti garantite dai produttori. Per un risultato finale di pura eccellenza.

ACOUSTIK PLUS · MAPLE · 500 COVERING SYSTEM
Comune di Livorno, Italy

WOOD CEILINGS & COVERINGS
ACOUSTIK PLUS

Acoustic performance & fire resistance
Performance acustica e resistenza al fuoco

Acoustik Plus is CBI Europe's Hi-tech revolution line that guarantees:

- Fire resistance
- Dimensional stability
- Resistance to humidity
- Excellent acoustic performance

Panels consist of high density plaster fibreboard 1250 kg/m³ (class A1) thickness 14 mm., natural wood veneer essences, and the edges are of genuine solid wood. The wood covering and backing are both treated with special fire resistant coatings, which are guaranteed by their manufacturers, thus giving the panels the result of sheer excellence.

Acoustik Plus è la linea Hi-tech revolution di CBI Europe che garantisce:

- Resistenza al fuoco
- Stabilità dimensionale
- Resistenza all'umidità
- Performance acustiche eccellenti

Composta da elementi in gesso/fibre di legno, ad altissima densità 1250 kg/m³ (classe A1) spessore 14 mm, impiallacciati con essenze di legno naturale e bordati con massello di vero legno. Il rivestimento, a vista e sul retro, è trattato con vernici intumescenti garantite dai produttori. Per un risultato finale di pura eccellenza.



FIRE RESISTANCE
RESISTENZA
AL FUOCO



POINTS LEED CERTIFICATION
PUNTEGGIO LEED



ACOUSTIC ABSORPTION
FONOASSORBENZA



INSPECTABLE
ISPEZIONABILE



EXTENDED
WORKING LIFE
DURABILITÀ



MOISTURE RESISTANCE
RESISTENZA ALL'UMIDITÀ



FSC WOOD CERTIFIED
LEGNO CERTIFICATO FSC



ANTI-SEISMIC
ANTI SISMICO



natural wood
legno naturale

plaster fibreboard panel
pannello gesso/fibre di legno

natural wood
legno naturale



high density plaster fibreboards
gesso/fibre di legno ad alta densità





ACOUSTIK PLUS · MAPLE · 500 COVERING SYSTEM

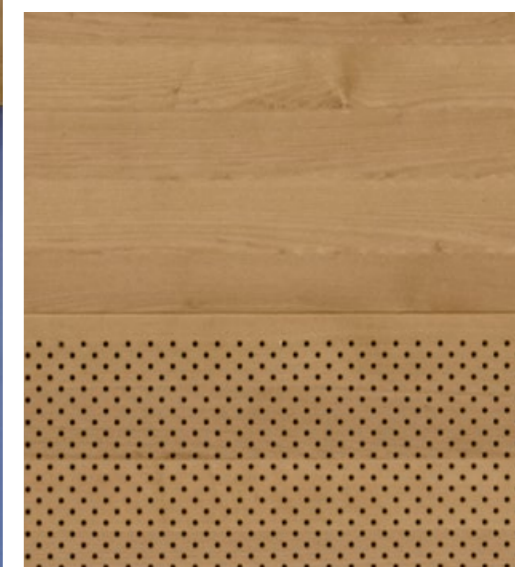
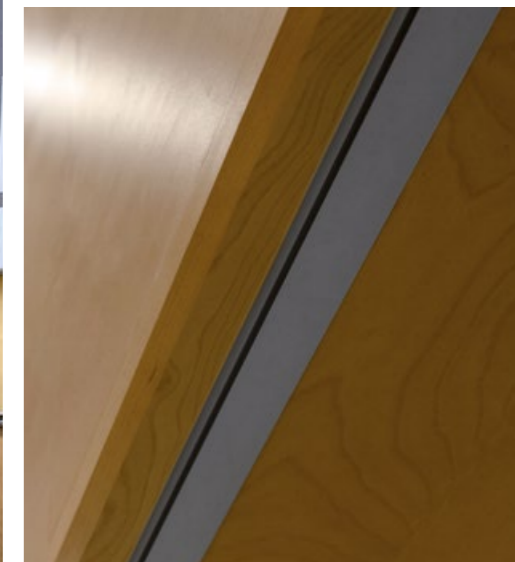

Panels can be installed in suspended ceilings and wall claddings using a variety of mounting systems.

I pannelli possono essere installati a controsoffitto oppure come rivestimento di pareti, seguendo diversi schemi di montaggio.



ACOUSTIC ABSORPTION
FONOASSORBENZA

Sound absorption properties vary from one type of panel and strip to another, depending on the characteristics of the perforations or slots. Special perforations can be produced to order.

Alle diverse tipologie di pannello ed in funzione della foratura, corrispondono differenti proprietà d'assorbimento acustico. Eventuali perforazioni speciali possono essere fornite su richiesta.

ACOUSTIK PLUS · MAPLE · PERF. F08 W= 0,65
wood concealed 200 system CWI 100% removable
Elica conference room · Fabriano, Italy

α_w
0,85

Sound Wood, designed for environment which requires the use of high performance, stylish acoustical insulation materials.

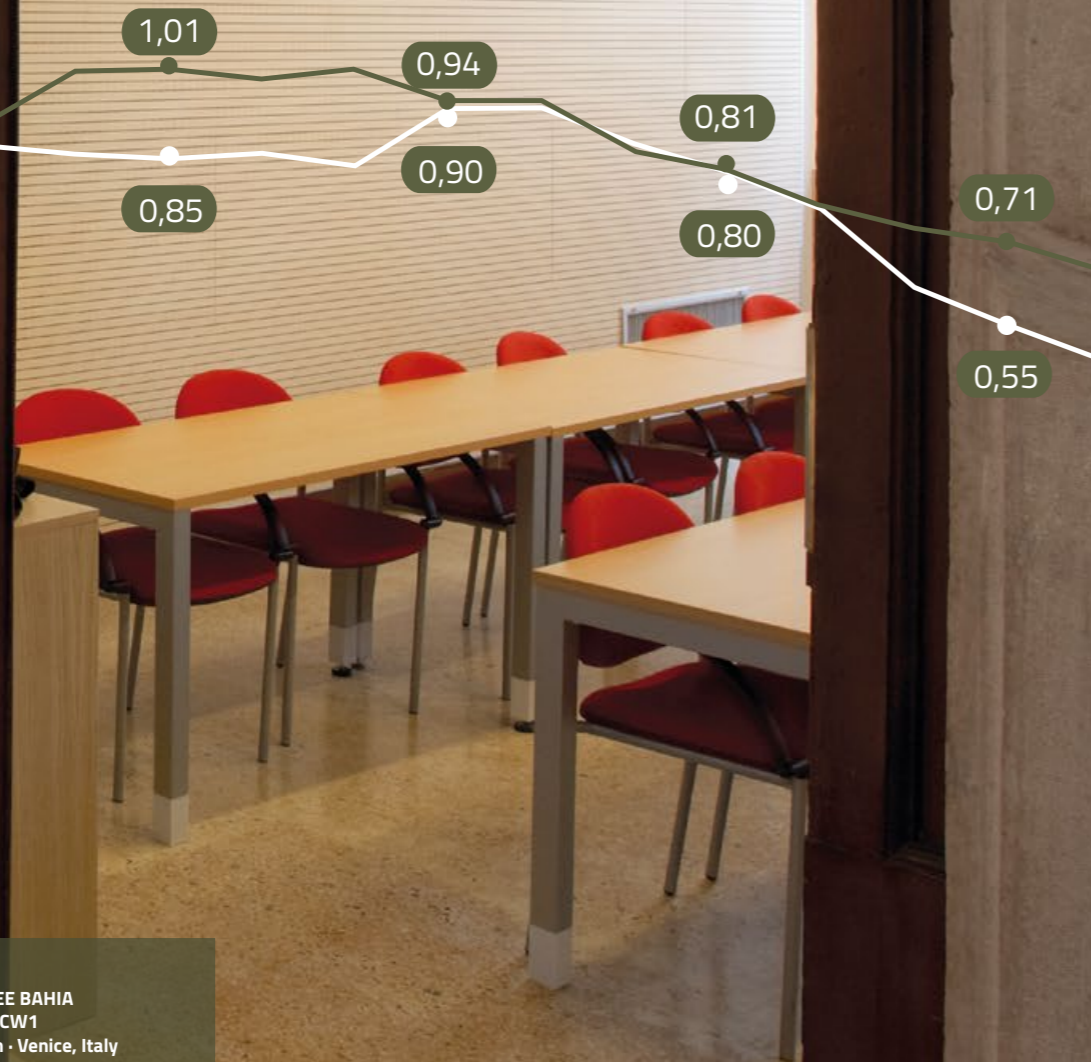

SOUND WOOD MELAMINE · ASH TREE BAHIA
CW3016 WOOD COVERING SYSTEM CW1
Patriarchal Institution Of The Vatican · Venice, Italy

WOOD CEILINGS & COVERINGS SOUND WOOD

The acoustically perfect system *Il sistema acusticamente perfetto*

Harmony, warmth, perfect acoustics, that is what you get from Sound Wood Ceilings and Wall Panels.

With a series of sound-absorbing elements having open horizontal or vertical slots and through perforation, and a wide range of colours and finishes, this system guarantees excellent acoustic results.

It is ideal for auditoriums, theatres, airports, conference rooms, offices and all environments which need to be elegant and at the same time, be soundproofed.

Sound Wood is the perfect solution for the best designers who face the problems of acoustic correction.

Armonia, calore, acustica perfetta: questo è Sound Wood Ceilings & Wall Panels di CBI Europe.

Con una serie di elementi fonoassorbenti che presentano fessature orizzontali o verticali a vista e fori passanti, in una vasta gamma di colori ed elementi di finitura, questo sistema garantisce risultati acustici di eccellenza.

Ideale per auditorium, teatri, aeroporti, sale conferenza, uffici e per tutti gli ambienti che richiedono l'utilizzo di materiali acusticamente performanti ed esteticamente raffinati.

È la risposta concreta alle esigenze dei migliori progettisti che affrontano il problema della correzione acustica.



FIRE RESISTANCE
RESISTENZA
AL FUOCO



POINTS LEED CERTIFICATION
PUNTEGGIO LEED



ACOUSTIC ABSORPTION
FONOASSORBENZA



ANTI-SEISMIC
ANTI SISMICO



EXTENDED
WORKING LIFE
DURABILITÀ



QUICK INSTALLATION
INSTALLAZIONE RAPIDA



FSC WOOD CERTIFIED
LEGNO CERTIFICATO FSC



INSPECTABLE
ISPEZIONABILE

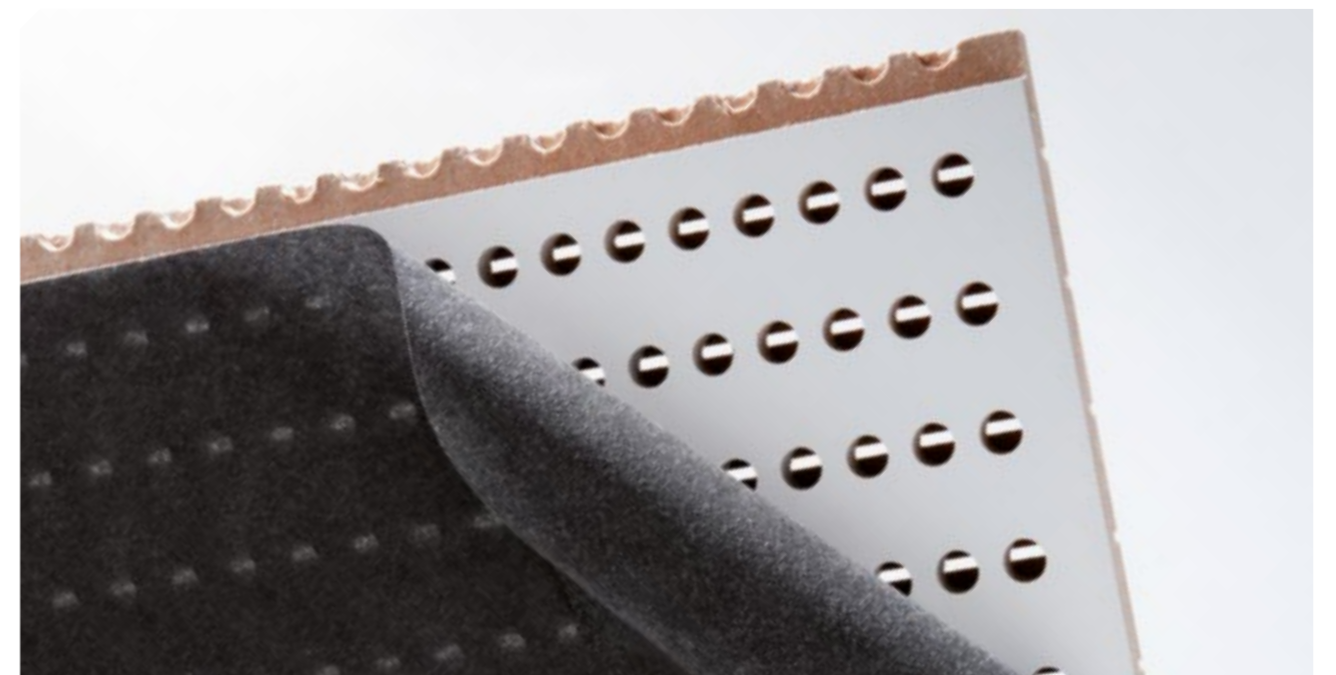

SOUND WOOD
Integration with
any architecture.

Integrazione con qualsiasi
architettura.



SOUND WOOD MELAMINE · ASH TREE BAHIA
3232 WOOD COVERING SYSTEM CW1
Patriarchal Institution Of The Vatican · Venice, Italy



WOOD LAMELLA 301 SYSTEM
Coop · Terni, Italy

WOOD CEILINGS & COVERINGS LAMELLA SYSTEM

Precise, modular design

Design preciso e modulare

Varying slat size, gaps between slats, and the insulation and cavity depth to the rear of the panel control the sound absorption produced.

Our unique suspension system makes mounting and demounting easy, is durable and reliable, and is aesthetically very discrete.

- Modern aesthetics for environments with a welcoming and natural atmosphere.
- Exclusive in-line assembly structure: simple, quick to install, with customizable gap on request.
- Seismic safety.

Le dimensioni variabili delle lamelle, gli spazi tra le lamelle e l'isolamento e la profondità della cavità sul retro del pannello controllano l'assorbimento acustico prodotto.

Il nostro esclusivo sistema di sospensione facilita il montaggio e lo smontaggio, è durevole e affidabile ed esteticamente molto discreto.

- *Estetica moderna per ambienti dall'atmosfera accogliente e naturale.*
- *Struttura esclusiva di montaggio in linea: semplice, veloce da installare.*
- *Sicurezza antisismica.*



EUROCLASS
B s2 d0



POINTS LEED CERTIFICATION
PUNTEGGIO LEED



FSC WOOD CERTIFIED
LEGNO CERTIFICATO FSC



ANTI-SEISMIC
ANTI SISMICO



INSPECTABLE
ISPEZIONABILE



QUICK INSTALLATION
INSTALLAZIONE RAPIDA



ACOUSTIC ABSORPTION
FONOASSORBENZA



EXTENDED
WORKING LIFE
DURABILITÀ





WOOD LAMELLA 301 SYSTEM
Conad hypermarket · Ancona, Italy





WOOD LAMELLA 302 SYSTEM
Varna Airport · Bulgaria



solid wood *legno naturale*

SOLID WOOD LAMELLA SYSTEM

Modern and natural atmosphere

Atmosfere moderne e naturali

Solid wood, with a thickness of 20/32/40 mm, with specific structure produced by CBI Europe.

Solid Wood Lamella 302 System: ceilings.

Solid Wood Lamella 504 System: wall coverings.

The positioning of the wooden slats takes place with a black metal profile, which is equipped with a special metallic tongue. This metal tab makes the system completely inspectable and resistant in the event of earthquakes. The systems guarantee rapid installation, speeding up the installation phases and respecting all the requirements of planarity and orthogonality.

- Modern aesthetics for environments with a welcoming and natural atmosphere.
- Exclusive in-line assembly structure: simple, quick to install, with customizable gap on request.
- Seismic safety.

Lamella in solid wood, spessore 20/32/40 mm, con specifica struttura di sostegno prodotta da CBI Europe.

Versioni disponibili:

Solid Wood Lamella 302 System: controsoffitto.

Solid Wood Lamella 504 System: rivestimento a parete.

Le lamelle vengono posizionate su di un profilo metallico nero, tramite una speciale linguetta metallica che rende il sistema completamente ispezionabile e resistente in caso di terremoti. Il sistema consente una rapida installazione, velocizzando le fasi di posa e rispettando tutti i requisiti di planarità ed ortogonalità.

- *Estetica moderna per ambienti dall'atmosfera accogliente e naturale.*
- *Struttura esclusiva di montaggio in linea: semplice, veloce da installare.*
- *Sicurezza antisismica.*



ANTI-SEISMIC
ANTI SISMICO



POINTS LEED CERTIFICATION
PUNTEGGIO LEED



FSC WOOD CERTIFIED
LEGNO CERTIFICATO FSC



INSPECTABLE
ISPEZIONABILE



FIRE RESISTANCE
RESISTENZA
AL FUOCO



QUICK INSTALLATION
INSTALLAZIONE RAPIDA



ACOUSTIC ABSORPTION
FONOASSORBENZA



EXTENDED
WORKING LIFE
DURABILITÀ

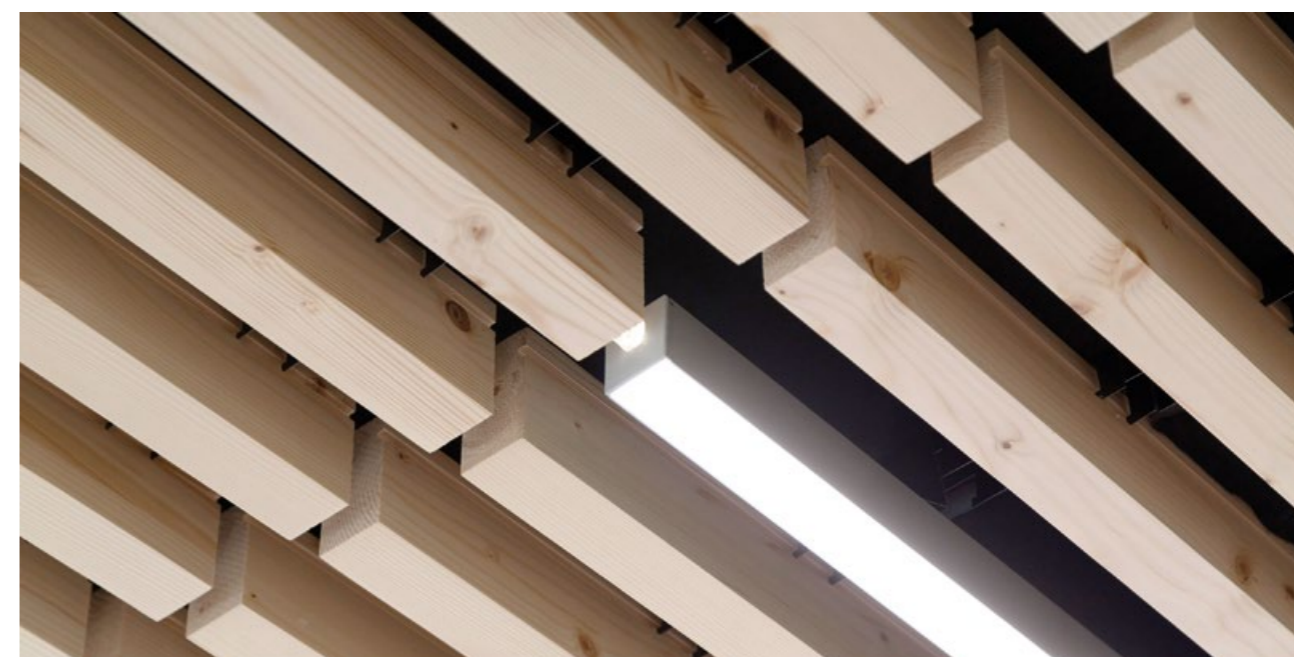

SOLID WOOD LAMELLA 302 SYSTEM

SPECIAL PANELS

WALL SOUND ABSORPTION

Noise control in any space

Controllo del rumore in ogni ambiente

To integrate the sound absorption of the walls and improve comfort in any environment - from the office to the areas dedicated to public use - CBI Europe has designed a wall absorption system, which can be easily installed on any type of surface. Available for both custom and standard measurements 60x120 mm / 30x120 mm, this system ensures high performance of sound absorption and adapts to any kind of design and style.

Per integrare la fonoassorbenza delle pareti e migliorare il comfort in ogni tipo di ambiente - dall'ufficio ai locali di uso pubblico - CBI Europe ha progettato un sistema di assorbitori da parete facilmente installabili su ogni tipo di superficie. Realizzati sia su misura che nel formato standard 60x120 mm o 30x120 mm, garantiscono prestazioni di alta efficienza nell'assorbimento acustico integrandosi perfettamente in ogni tipologia di arredo.

30x120 mm 60x120 mm on request a richiesta



WALL SOUND ABSORPTION
SOUND WOOD PANEL · WHITE · CW3216 · $\alpha_w=0,50$ · CW3232 · $\alpha_w=0,30$



WALL SOUND ABSORPTION
SOUND WOOD PANEL · WHITE · CW1516 · $\alpha_w=0,75$
> SOUND WOOD PANEL · WHITE · CW1632 · $\alpha_w=0,75$

TYPE OF PANELS TIPOLOGIA DI PANNELLI

SHERWOOD - MDF HIGH DENSITY *MDF ALTA DENSITÀ*

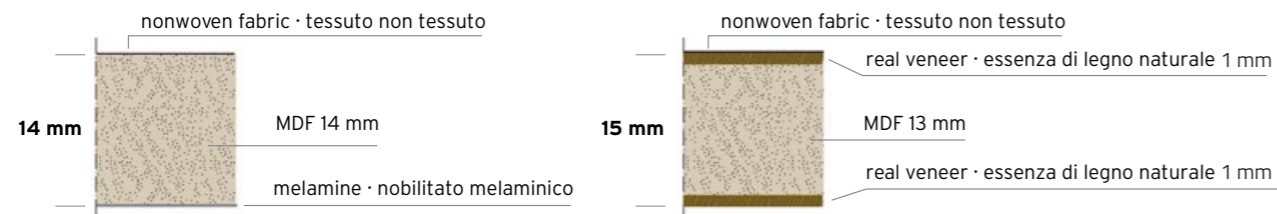

MDF HIGH DENSITY · *MDF ALTA DENSITÀ*

Internal bond · <i>Resistenza allo strappo</i>	EN 319	0,65 / 1,1 N/mm ²
C.R.F.	EN 310	22 / 35,1 N/mm ²
M.O.E.	EN 310	2500 3180 N/mm ²
Thickness swelling 24H (max) · <i>Rigonfiamento 24H (max)</i>	EN 317	15,0 / 12,3 %
Surface soundness · <i>Strappo superficiale</i>	EN 311	1,2 / 1,8 N/mm ²
MDF Density · <i>Densità</i>	EN 323	780 Kg/m ³ +/- 5%
Thickness Tolerance · <i>Tolleranza di spessore</i>	EN 324-1	+/- 0,2 mm
Length and width tolerance · <i>Tolleranza lunghezza e larghezza</i>	EN 324-1	+/- 0,3 mm
Squareness · <i>Squadro</i>	EN 324-2	+/- 0,3 mm
Moisture content · <i>Umidità</i>	EN 322	4% - 11%
Grit content · <i>Contenuto in silice</i>	ISO 3340	< 0,05%
Formaldehyde · <i>Formaldeide</i>	EN 120	< 9 mg / 100 g
Fire reaction class · <i>Classe di reazione al fuoco</i>		B s₂ d₀

SHERWOOD - MULTILAYERS *MULTISTRATO*

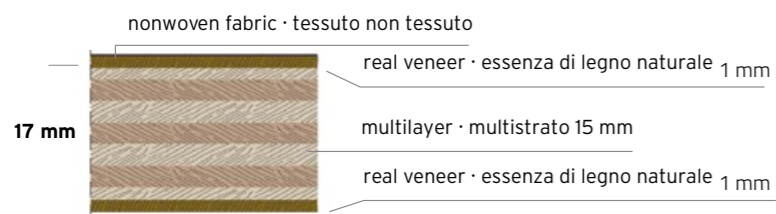

MULTILAYERS · *MULTISTRATO*

Thickness · <i>Spessore</i>	EN 315	15 mm
Layers · <i>Strati</i>	EN 315	n° 7
Mass · <i>Massa volumica</i>	EN 323	Kg/m ³ 410 +/- 10%
Resistance to bending · <i>Resistenza alla flessione</i>		
Longitudinal · <i>Longitudinale</i>	EN 310	25 N/mm ²
Transversal · <i>Trasversale</i>	EN 310	25 N/mm ²
Thermal conductivity · <i>Conduttività termica</i>	EN 10456	W/m K 0,12
Moisture content · <i>Umidità</i>	EN 322	% 8 - 12
Formaldehyde · <i>Formaldeide</i>		E1
Fire reaction class · <i>Classe di reazione al fuoco</i>		
Standard	ISO 13986	Dfl s1
On demand · <i>A richiesta</i>	EN 13501-1	B s ₂ d ₀

ACOUSTIK PLUS - FIRE-PROOF PLASTER FIBREBOARD *GESSO/FIBRE DI LEGNO*

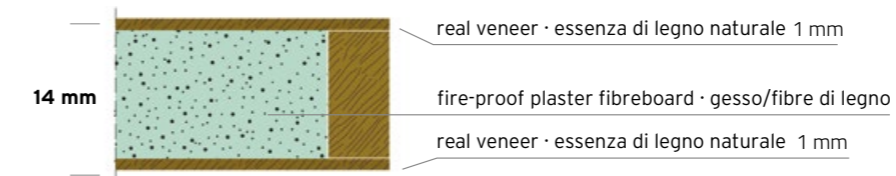

FIRE-PROOF PLASTER FIBREBOARD · *GESSO/FIBRE DI LEGNO*

Internal bond · <i>Resistenza allo strappo</i>	EN 319	0,35 / 1,1 N/mm ²
C.R.F.	EN 310	9 N/mm ²
M.O.E.	EN 310	4000 N/mm ²
Thickness swelling 24H (max) · <i>Rigonfiamento 24H (max)</i>	EN 317	0,08 %
Surface soundness · <i>Strappo superficiale</i>	EN 311	18 N/mm ²
Thickness Tolerance · <i>Tolleranza di spessore</i>	EN 324-1	+/- 0,5 mm
Length and width tolerance · <i>Toll. lunghezza e larghezza</i>	EN 324-1	+/- 0,3 mm
Squareness · <i>Squadro</i>	EN 324-2	+/- 0,3 mm
Moisture content · <i>Umidità</i>	EN 322	2%
Grit content · <i>Contenuto in silice</i>	ISO 3340	0
Formaldehyde · <i>Formaldeide</i>	EN 120	0
Fire reaction class · <i>Classe di reazione al fuoco</i>		A2 s₁ d₀

SOUND WOOD - MDF HIGH DENSITY *MDF ALTA DENSITÀ*

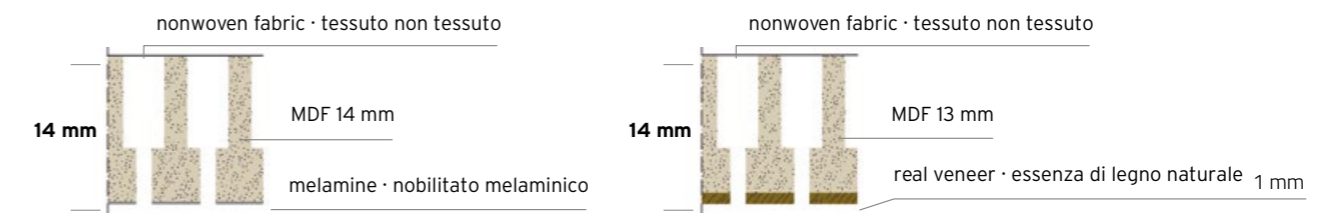

MDF HIGH DENSITY · *MDF ALTA DENSITÀ*

Internal bond · <i>Resistenza allo strappo</i>	EN 319	0,65 / 1,1 N/mm ²
C.R.F.	EN 310	22 / 35,1 N/mm ²
M.O.E.	EN 310	2500 3180 N/mm ²
Thickness swelling 24H (max) · <i>Rigonfiamento 24H (max)</i>	EN 317	15,0 / 12,3 %
Surface soundness · <i>Strappo superficiale</i>	EN 311	1,2 / 1,8 N/mm ²
MDF Density · <i>Densità</i>	EN 323	780 Kg/m ³ +/- 5%
Thickness Tolerance · <i>Tolleranza di spessore</i>	EN 324-1	+/- 0,2 mm
Length and width tolerance · <i>Tolleranza lunghezza e larghezza</i>	EN 324-1	+/- 0,3 mm
Squareness · <i>Squadro</i>	EN 324-2	+/- 0,3 mm
Moisture content · <i>Umidità</i>	EN 322	4% - 11%
Grit content · <i>Contenuto in silice</i>	ISO 3340	< 0,05%
Formaldehyde · <i>Formaldeide</i>	EN 120	< 9 mg / 100 g
Fire reaction class · <i>Classe di reazione al fuoco</i>		B s₂ d₀

TYPE OF PANELS TIPOLOGIA DI PANNELLI

SOUND WOOD · MULTILAYERS *MULTISTRATO*

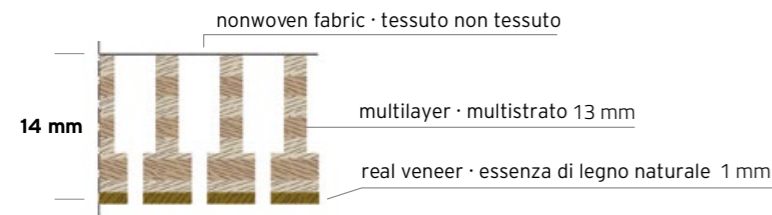

MULTILAYERS · *MULTISTRATO*

Thickness · <i>Spessore</i>	EN 315	15 mm
Layers · <i>Strati</i>	EN 315	n° 7
Mass · <i>Massa volumica</i>	EN 323	Kg/m ³ 410 +/- 10%
Resistance to bending · <i>Resistenza alla flessione</i>		
Longitudinal · <i>Longitudinale</i>	EN 310	25 N/mm ²
Transversal · <i>Trasversale</i>	EN 310	25 N/mm ²
Thermal conductivity · <i>Conduttività termica</i>	EN 10456	W/m K 0,12
Moisture content · <i>Umidità</i>	EN 322	% 8 - 12
Formaldehyde · <i>Formaldeide</i>		E1
Fire reaction class · <i>Classe di reazione al fuoco</i>		
Standard	ISO 13986	Dfl s1
On demand · <i>A richiesta</i>	EN 13501-1	B s2 d0

LAMELLA · MDF HIGH DENSITY *MDF ALTA DENSITÀ*



MDF HIGH DENSITY · *MDF ALTA DENSITÀ*

Internal bond · <i>Resistenza allo strappo</i>	EN 319	0,65 / 1,1 N/mm ²
C.R.F.	EN 310	22 / 35,1 N/mm ²
M.O.E.	EN 310	2500 3180 N/mm ²
Thickness swelling 24H (max) · <i>Rigonfiamento 24H (max)</i>	EN 317	15,0 / 12,3 %
Surface soundness · <i>Strappo superficiale</i>	EN 311	1,2 / 1,8 N/mm ²
MDF Density · <i>Densità</i>	EN 323	780 Kg/m ³ +/- 5%
Thickness Tolerance · <i>Tolleranza di spessore</i>	EN 324-1	+/- 0,2 mm
Length and width tolerance · <i>Tolleranza lunghezza e larghezza</i>	EN 324-1	+/- 0,3 mm
Squareness · <i>Squadro</i>	EN 324-2	+/- 0,3 mm
Moisture content · <i>Umidità</i>	EN 322	4% - 11%
Grit content · <i>Contenuto in silice</i>	ISO 3340	< 0,05%
Formaldehyde · <i>Formaldeide</i>	EN 120	< 9 mg / 100 g
Fire reaction class · <i>Classe di reazione al fuoco</i>		B s2 d0

FINISHES *FINITURE*

MELAMINE NOBILITATO MELAMINICO

> SHERWOOD · SOUND WOOD · LAMELLA



oak rock white · *rovere rock bianco*



elm tafira · *olmo tafira*

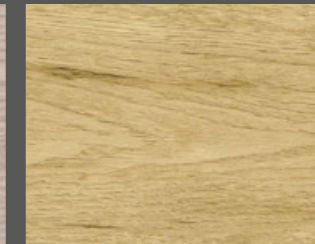

oak supreme · *rovere supremo*



oak bruges · *rovere bruges*

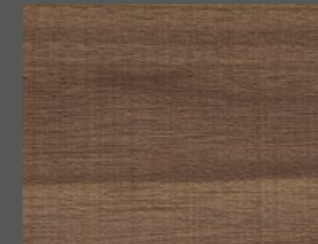

walnut athens · *noce athens*



white · *bianco*

REAL VENEER *IMPIALLACCIATO LEGNO*

> SHERWOOD · ACOUSTIK PLUS · SOUND WOOD · LAMELLA



maple · *acero*

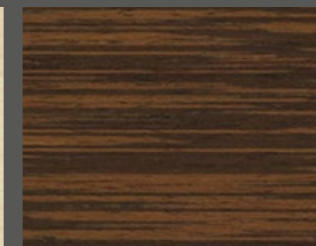

wengè



beech · *faggio*

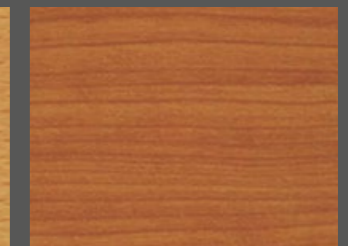

cherry · *ciliegio*



zebrano



ash tree · *frassino*



walnut 1 · *noce 1*

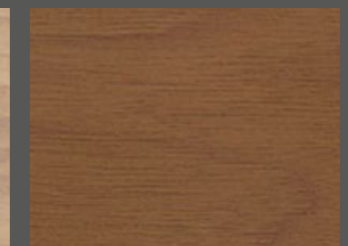

walnut 2 · *noce 2*



mahogany · *mogano*

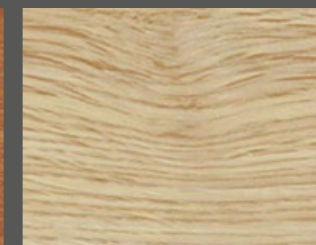

oak · *rovere*

The colour card shown on this page is purely for information purposes; please request samples. Please contact CBI Europe's Technical Office for special colour requirements which will be supplied only for orders of at least 800 sq.m. Wood system accessories are finished in aluminium or wood.

Le cartelle colori riportate sono puramente indicative, e si raccomanda la richiesta di campionatura. Per colori non presenti in cartella e soltanto per forniture di colore pari o superiori a 800 m², contattare l'ufficio tecnico. Gli accessori del sistema Wood possono essere in finitura alluminio o legno.

WOOD EXPO 100 SYSTEM



WOOD CONCEALED 200 SYSTEM

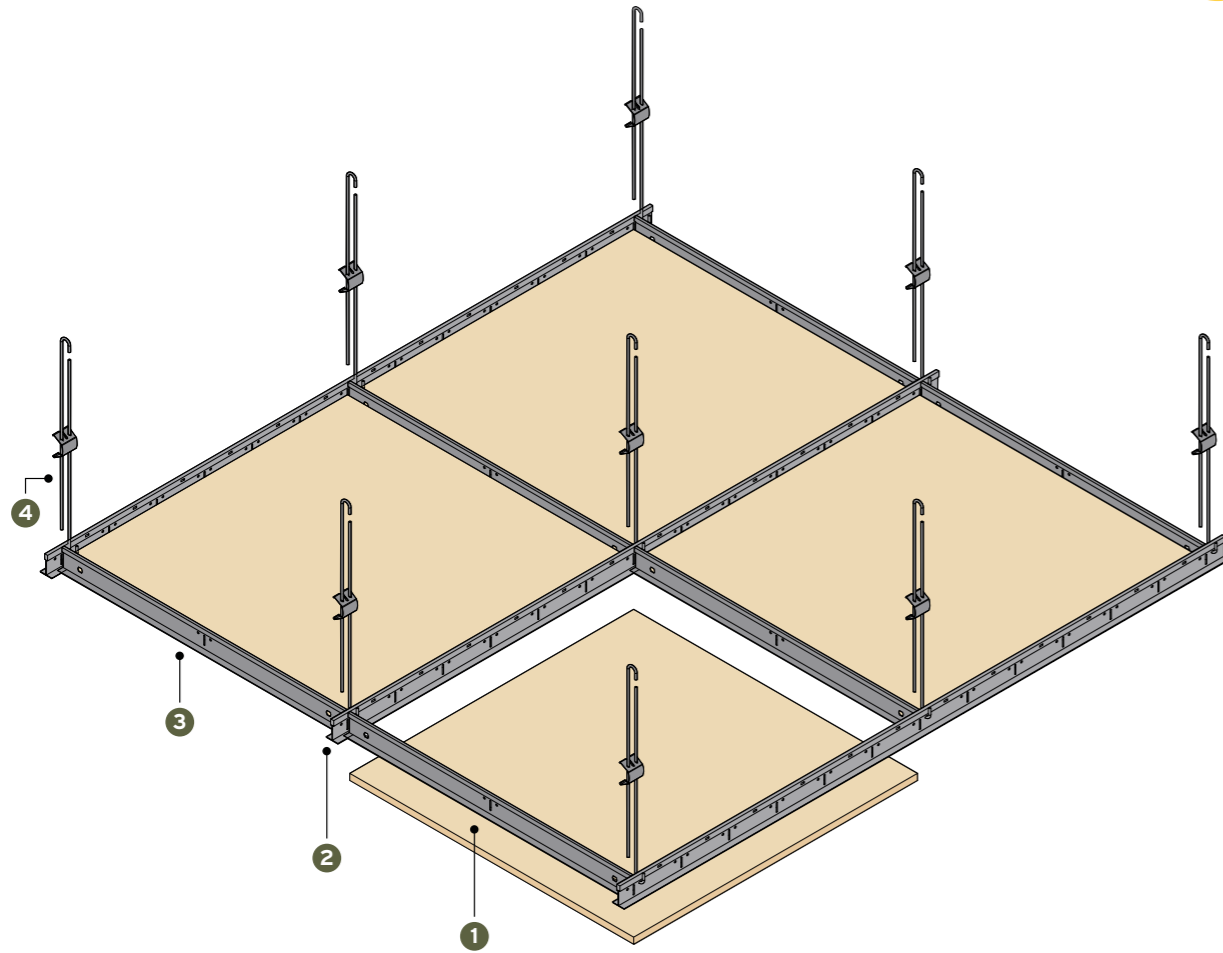

PANEL PANNELLO

dimension	type
square quadrato	· SHERWOOD MELAMINE
rectangular rettangolare	· SHERWOOD REAL VENEER
	· ACOUSTIK PLUS
	· SOUND WOOD

GRID SYSTEM STRUTTURA

- CWT
- CWR
- CWN
- CWX

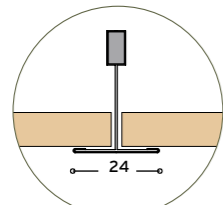

TRIM T24 > CWT

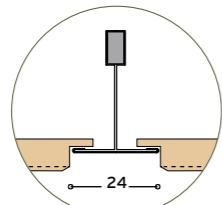

REVEAL T24 > CWR

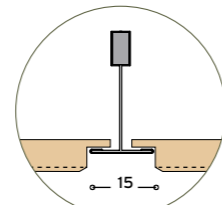

NARROW T15 > CWN

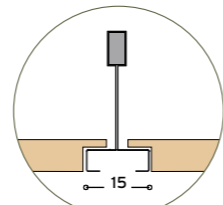

XLINE T15 > CWX

38

1	2	3	4
panel pannello 600x600 mm 600x1200 mm	main runner profilo portante CWT · CWR > PKH 3700 24x38x3700 mm CWN > PKA 3700 15x38x3700 mm CWX > BP 3600 15x42x3600 mm	cross tee profilo intermedio IKH 0600 24x38x600 mm IKHA 0600 24x38x600 mm BP 0600 15x42x600 mm	SOR suspension sospensione

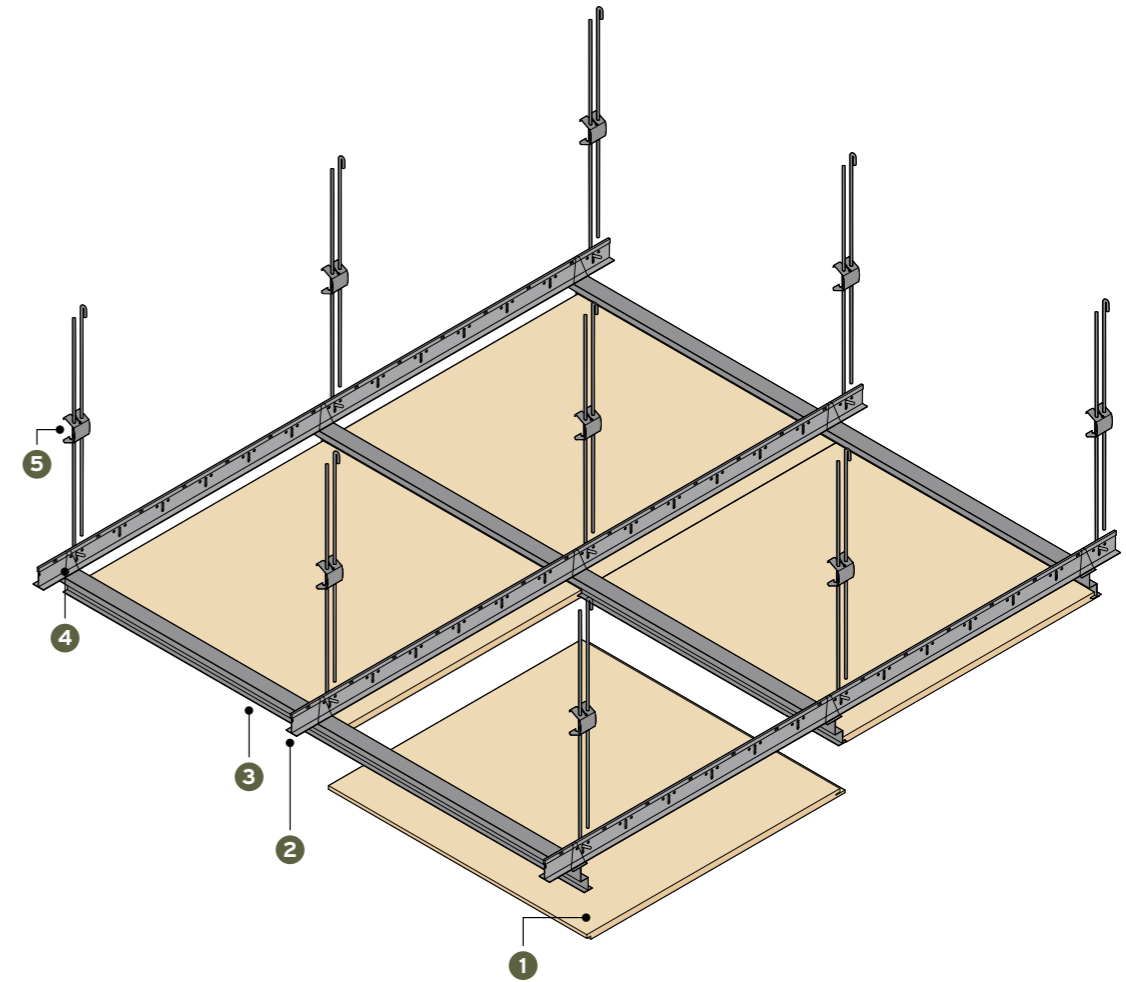

PANEL PANNELLO

dimension	type
square quadrato	· SHERWOOD MELAMINE
rectangular rettangolare	· SHERWOOD REAL VENEER
	· ACOUSTIK PLUS
	· SOUND WOOD

GRID SYSTEM STRUTTURA

- CWI

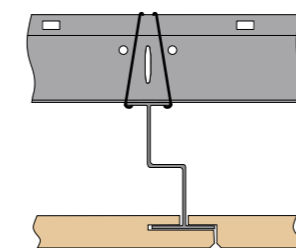

38

56

1	2	3	4	5
panel pannello 600x600 mm 600x1200 mm	P 3700 Z main runner profilo portante 24x38x3700 mm	Z 4000 W secondary profile profilo secondario 24x56x4000 mm	SP 38.1 cross connector raccordo ortogonale	SOR suspension sospensione

WOOD CONCEALED 200 SYSTEM **accessible**



INSPECTABLE
WITH TRAPDOOR
ISPEZIONABILE
CON BOTOLA

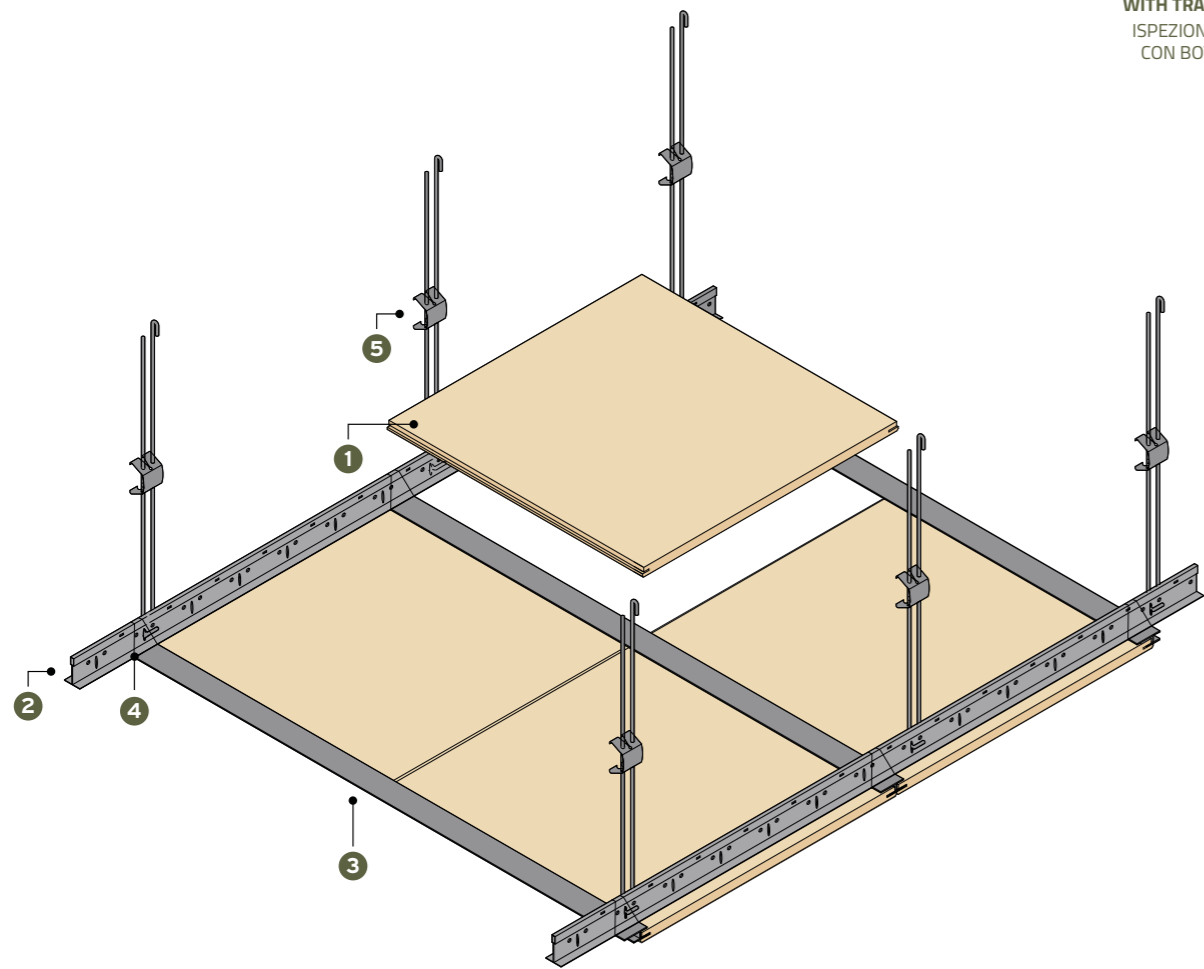

PANEL PANNELLO

dimension	type
square quadrato	• SHERWOOD MELAMINE
rectangular rettangolare	• SHERWOOD REAL VENEER
	• ACOUSTIK PLUS
	• SOUND WOOD

GRID SYSTEM STRUTTURA

• CWA

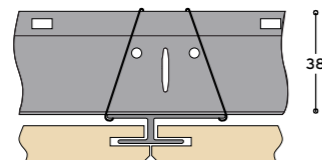

1	2	3	4	5
panel pannello 600x600 mm 600x1200 mm	P 3700 Z main runner profilo portante 24x38x3700 mm	PP 1001 secondary profile profilo secondario 36,5x12x4000 mm	SP 38.1 cross connector raccordo ortogonale	SOR suspension sospensione

WOOD CONCEALED 200 CWI SYSTEM

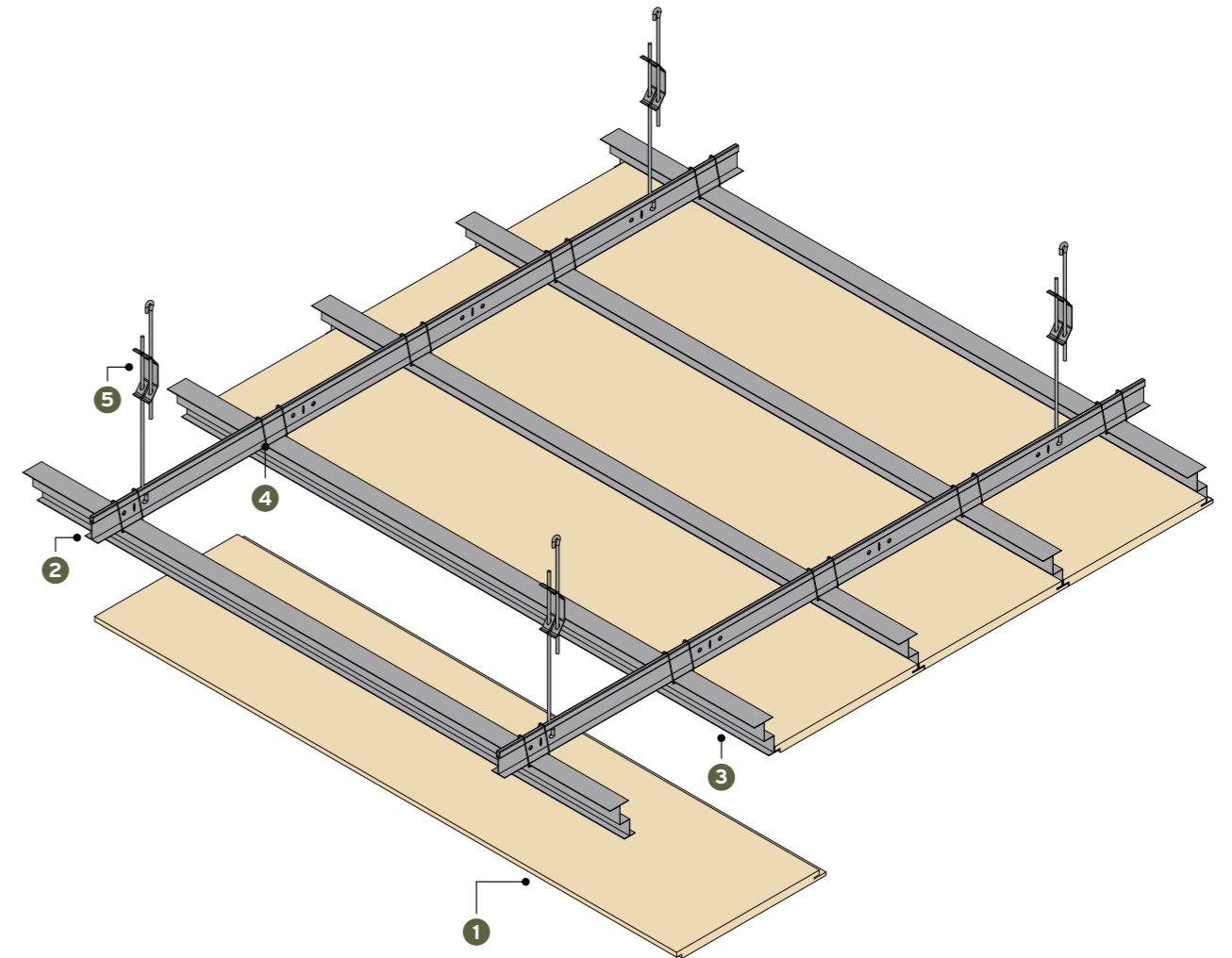

PANEL PANNELLO

dimension	type
square quadrato	• SHERWOOD MELAMINE
rectangular rettangolare	• SHERWOOD REAL VENEER
	• SOUND WOOD*

GRID SYSTEM STRUTTURA

• CWI

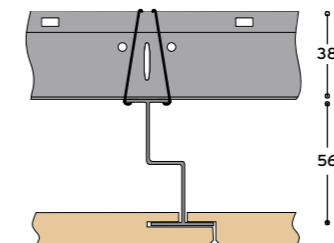

1	2	3	4	5
panel pannello Sherwood 600x600/1200 *Soundwood 256x1792	P 3700 Z main runner profilo portante 24x38x3700 mm	PP 1001 secondary profile profilo secondario 36,5x12x4000 mm	SP 38.1 cross connector raccordo ortogonale	SOR suspension sospensione

WOOD LAMELLA 300 SYSTEM

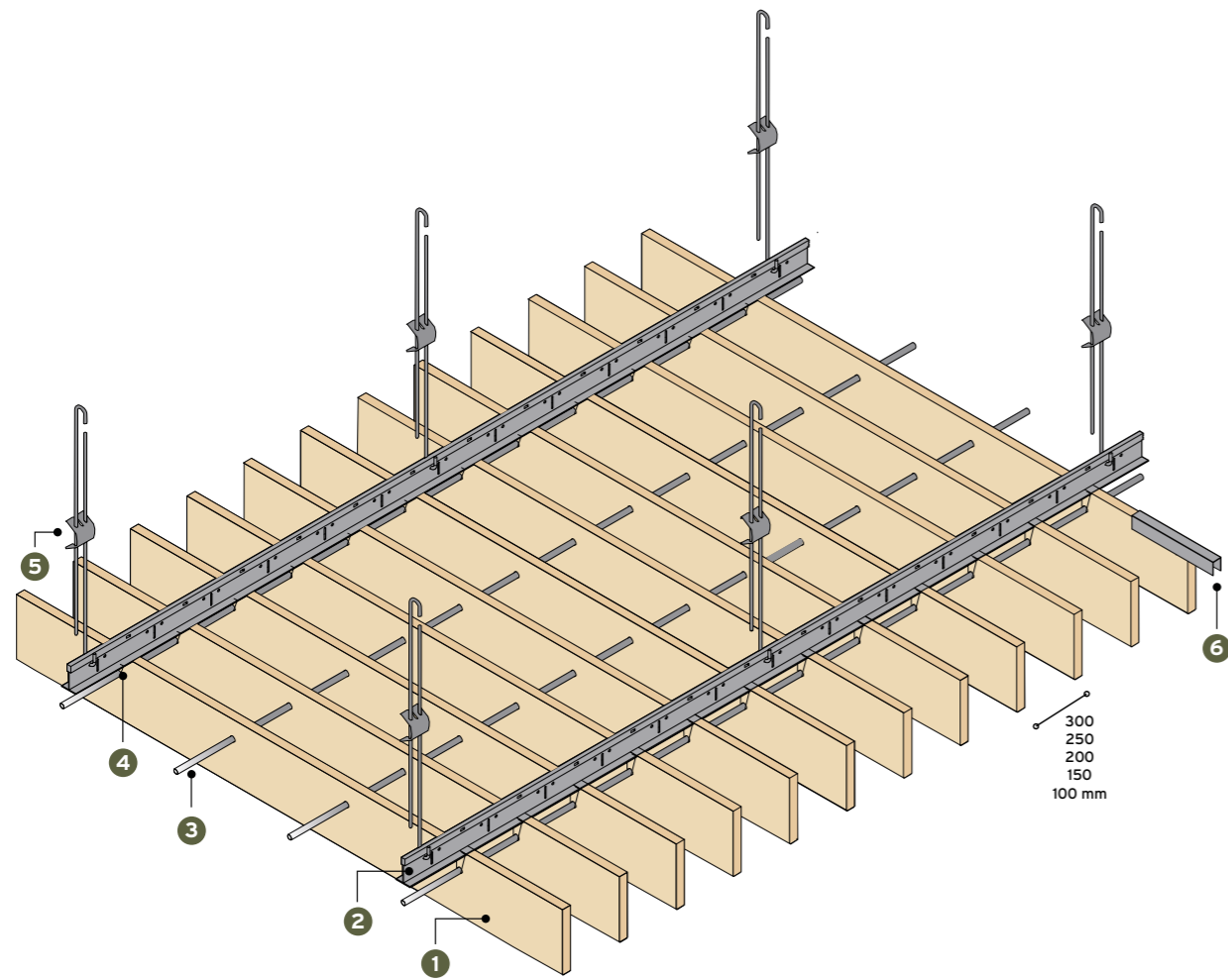

SLAT LAMELLA

dimension
H 100 / 150 / 200 mm
L 1200 / 1800

type
MELAMINE
REAL VENEER

GRID SYSTEM STRUTTURA

· CWG

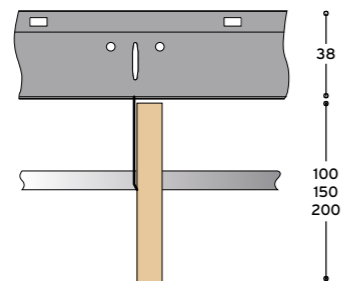

1	2	3	4	5	6
slat lamella H 100/150 /200 mm	P 3700 N main runner profilo portante 32x36x4000 mm	TU 08 aluminium tube tubolare in alluminio Ø 8 mm	SP 39 spring molla	SOR suspension sospensione	SP81 connector for slat connettore per lamella

WOOD LAMELLA 301 SYSTEM

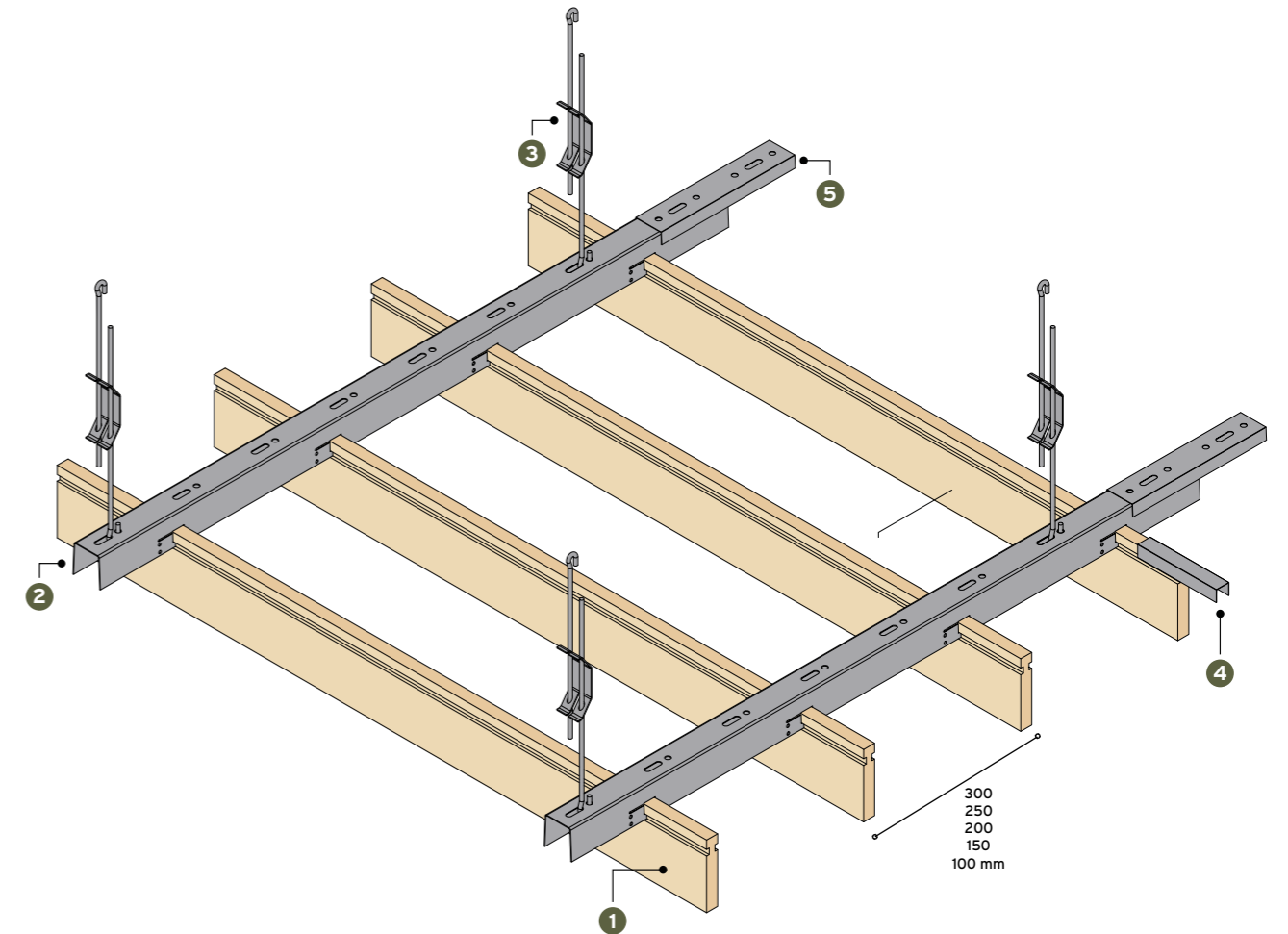

SLAT LAMELLA

dimension
H 100 / 150 / 200 mm
L 1200 / 1800

type
MELAMINE
REAL VENEER

GRID SYSTEM STRUTTURA

· CWF

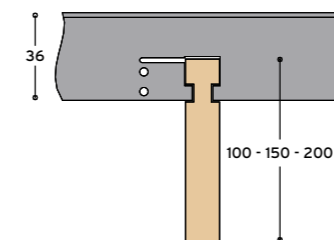

1	2	3	4	5
slat lamella H100/150/200 mm	T 91/N main runner profilo portante 32x36x4000 mm	SOR suspension sospensione	SP81 connector for slat connettore per lamella	CN81 connector for main runner connettore per profilo portante

SOLID WOOD LAMELLA 302 SYSTEM

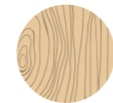

SOLID WOOD

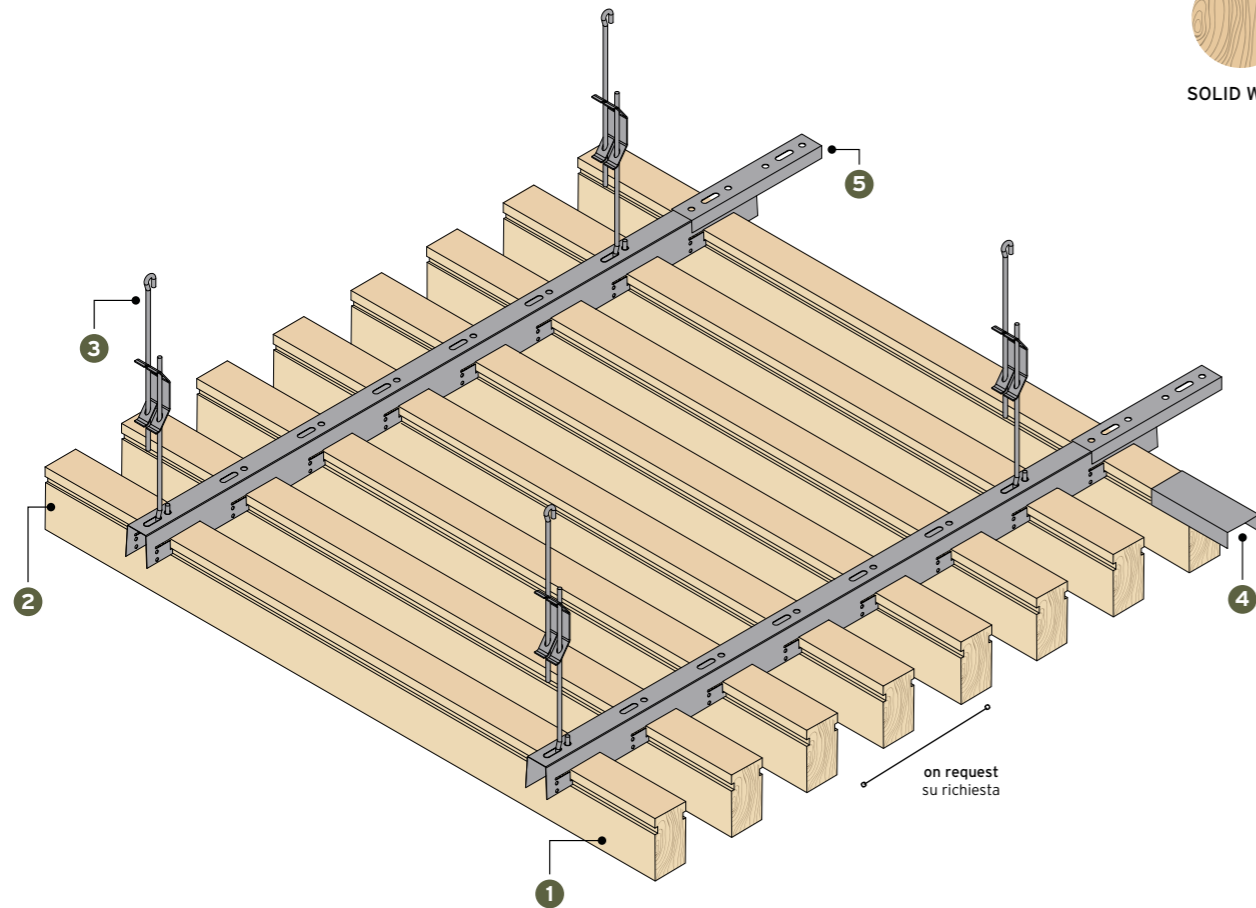

on request
su richiesta

SLAT LAMELLA

dimension type
H 40/50/60 mm SOLID WOOD
L 20/32/40 mm

GRID SYSTEM STRUTTURA

· CWF

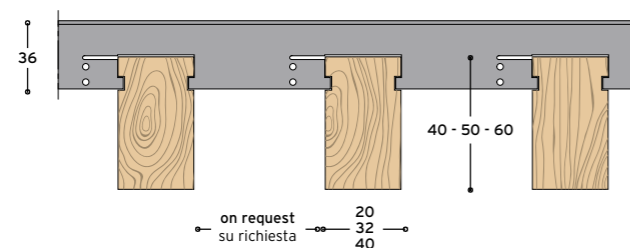

on request
su richiesta

1	2	3	4	5
slat lamella H 40/50/60 mm	T 91/N main runner profilo portante 32x36x4000 mm	SOR suspension sospensione	SP82 connector for slat connettore per lamella	CN82 connector for main runner connettore per profilo portante

WOOD CONCEALED 400 SYSTEM

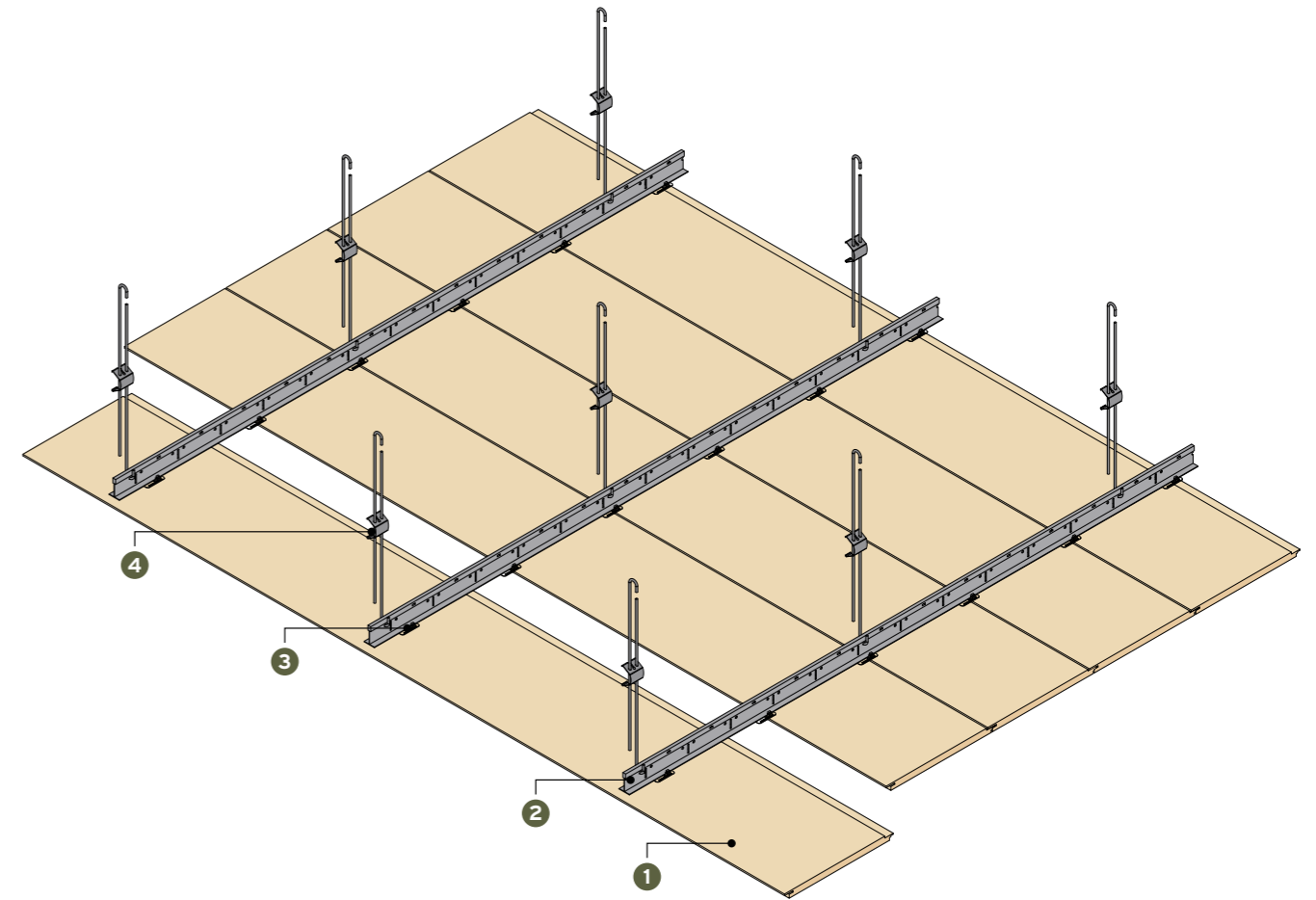

PANEL PANNELLO

dimension type
rectangular rettangolare · SOUND WOOD

GRID SYSTEM STRUTTURA

· CWB

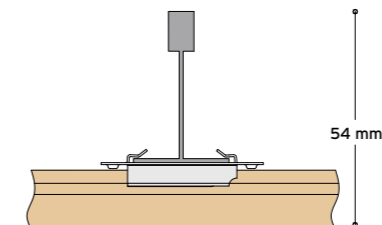

1	2	3	4
panel pannello	P 3700 Z main runner profilo portante 24x38x3700 mm	SP76 hidden suspension hook gancio di sospensione nascosto	SOR suspension sospensione

WOOD CONCEALED 401 SYSTEM

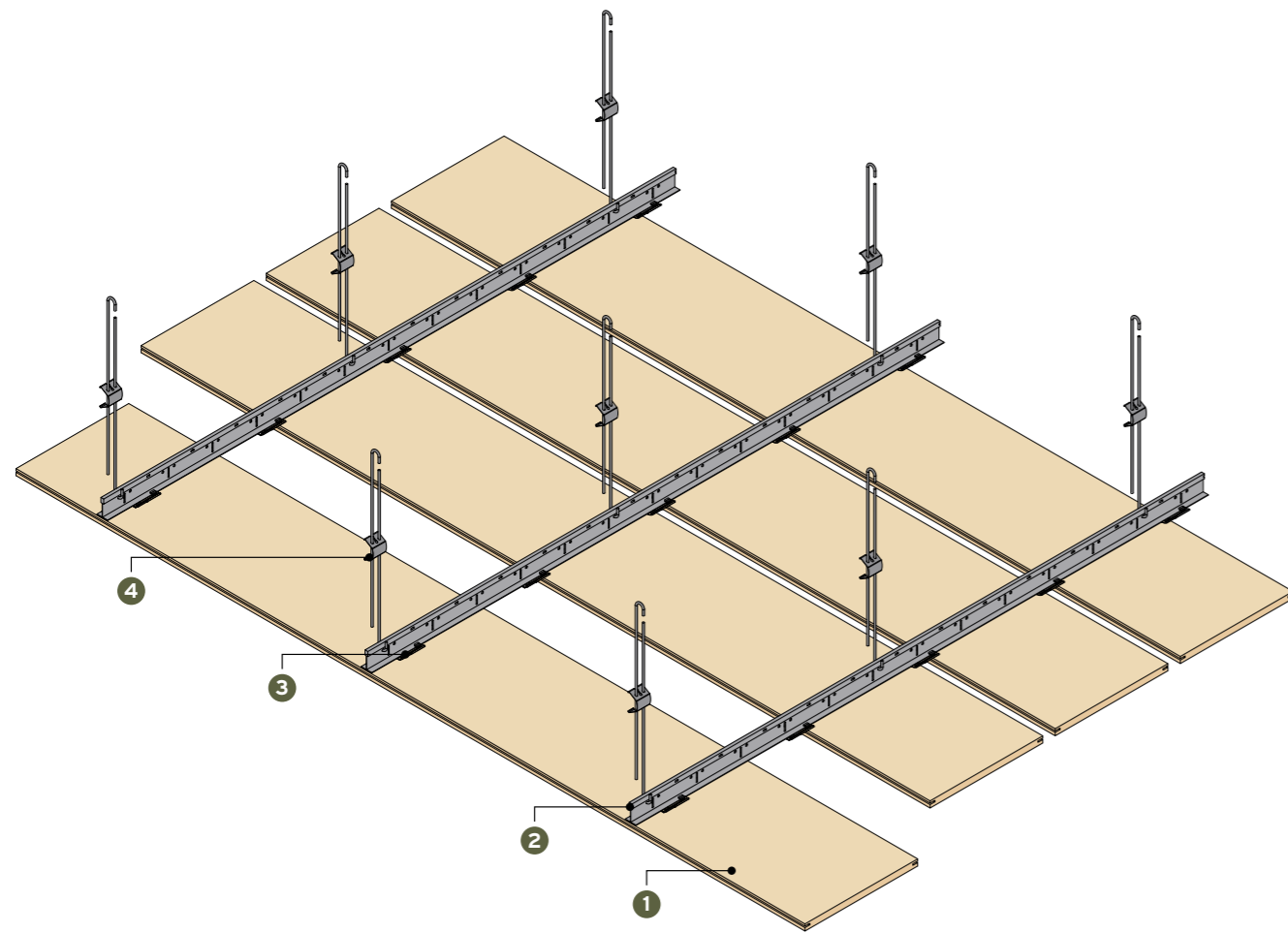

PANEL PANNELLO

dimension
rectangular rettangolare

type
· SOUND WOOD

GRID SYSTEM STRUTTURA

· CWC

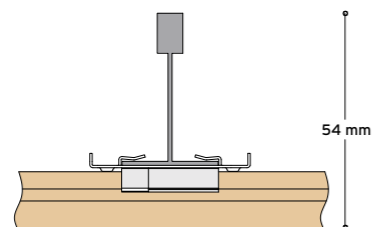

1	2	3	4
panel pannello	P 3700 Z main runner profilo portante 24x38x3700 mm	SP 78 spacer hook gancio distanziale gap fuga 20 mm	SOR suspension sospensione

WOOD COVERING 500 SYSTEM



EASY INSPECT



CUSTOM SIZE

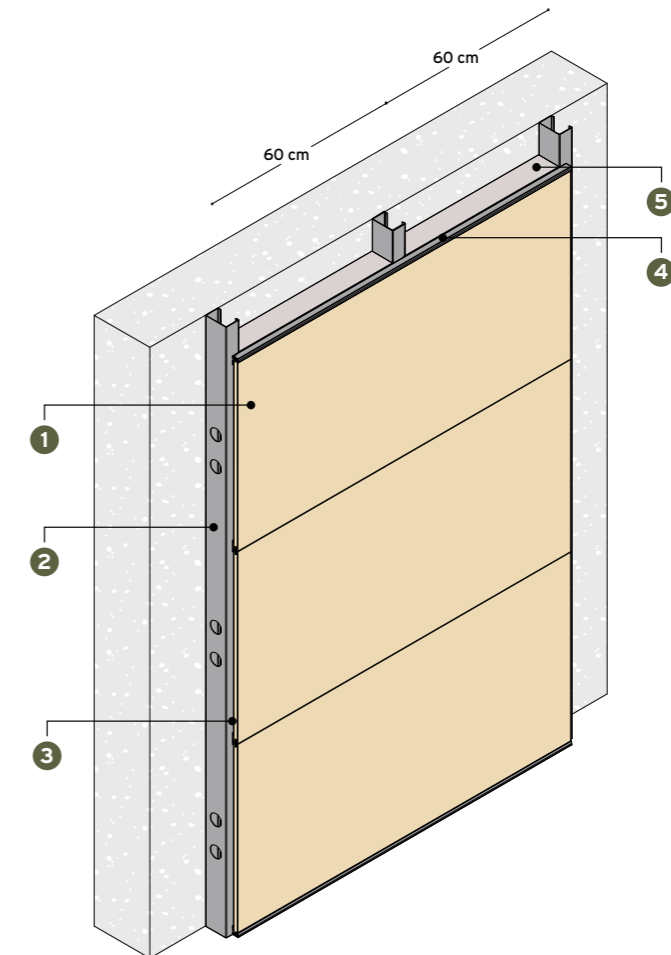

PANEL PANNELLO

dimension
square quadrato
rectangular rettangolare

type
· SHERWOOD MELAMINE
· SHERWOOD REAL VENEER
· ACOUSTIK PLUS
· SOUND WOOD

custom su misura

GRID SYSTEM STRUTTURA

· WC1

PP1001 / PP1001.N

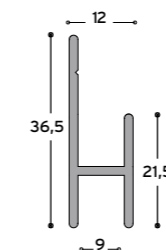

PP1002
Acoustik Plus

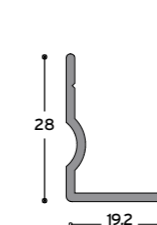

PP1003
Sherwood
Sound Wood

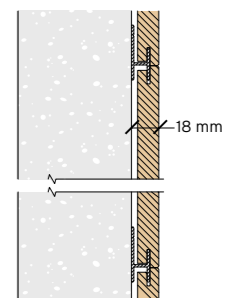
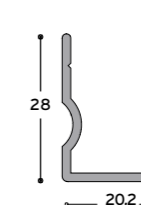

1	2	3	4	5	
panel pannello	M46 / 75 primary support structure struttura di sostegno primaria	PP1001 Acoustik Plus Sherwood PP1001.N Sound Wood	secondary profile profilo secondario	PP1002 Acoustik Plus PP1003 Sherwood Sound Wood	starting profile profilo di partenza
				PPN1 / 40.1 rockwool insulation lana di roccia 600 x 1200 mm	

WOOD COVERING 501 SYSTEM

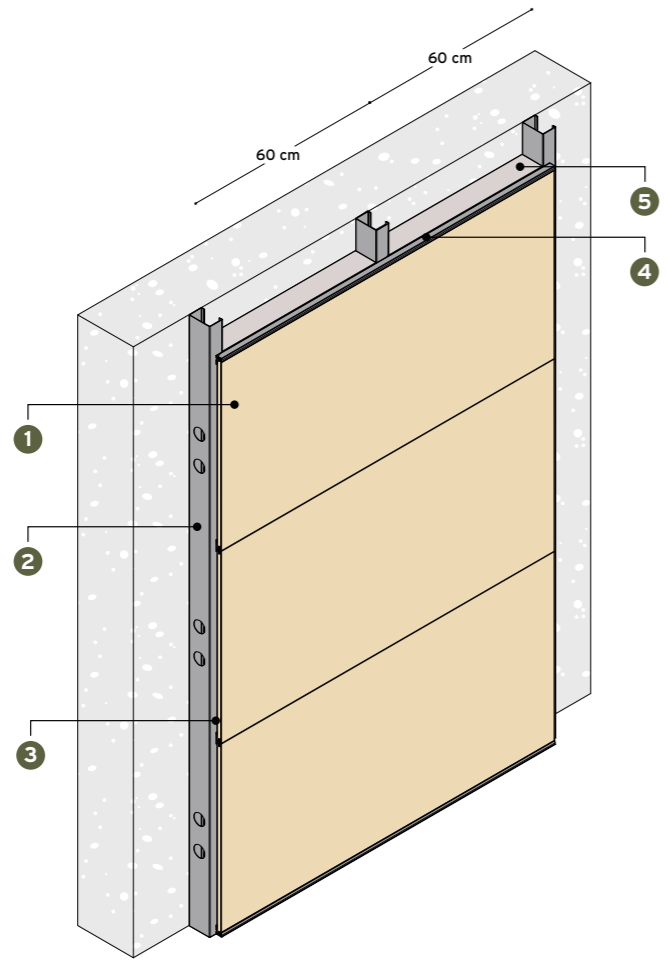

WOOD COVERING 502 SYSTEM

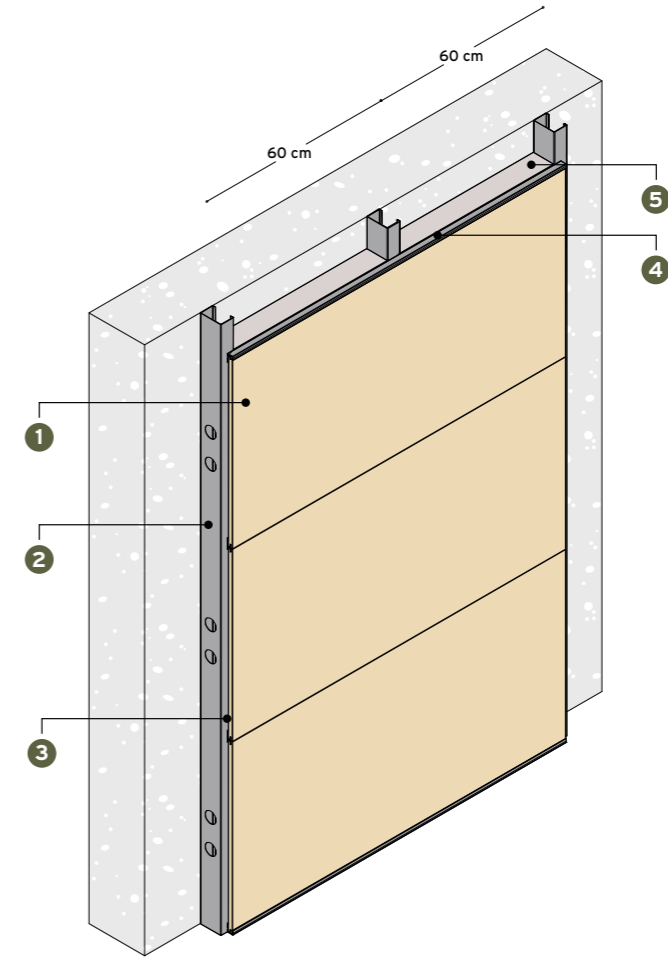

PANEL PANNELLO

dimension type
 square quadrato · SHERWOOD MELAMINE
 rectangular rettangolare · SHERWOOD REAL VENEER
 · ACOUSTIK PLUS
 · SOUND WOOD
 custom su misura

GRID SYSTEM STRUTTURA

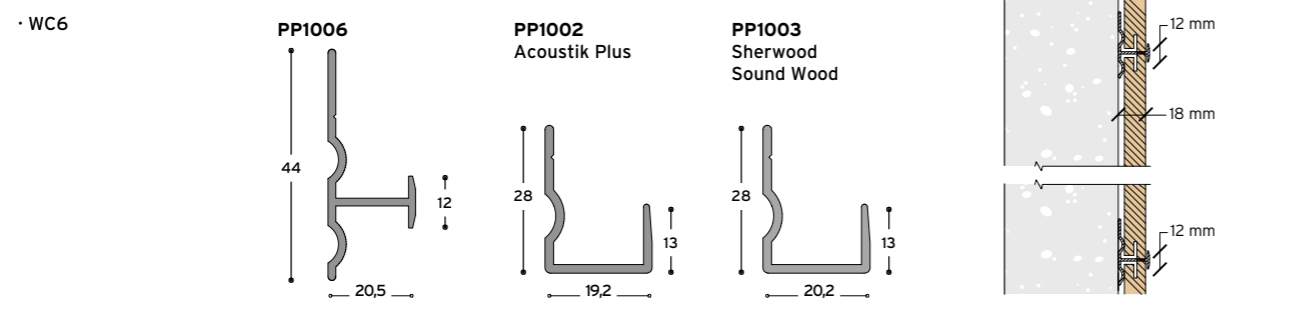

- 1** panel pannello
- 2** M46 / 75 primary support structure struttura di sostegno primaria
- 3** PP1006 secondary profile profilo secondario
- 4** PP1002 Acoustik Plus starting profile profilo di partenza
PP1003 Sherwood Sound Wood
- 5** PPN1 / 40.1 rockwool insulation lana di roccia 600 x 1200 mm

PANEL PANNELLO

dimension type
 square quadrato · SHERWOOD MELAMINE
 rectangular rettangolare · SHERWOOD REAL VENEER
 · ACOUSTIK PLUS
 · SOUND WOOD
 custom su misura

GRID SYSTEM STRUTTURA

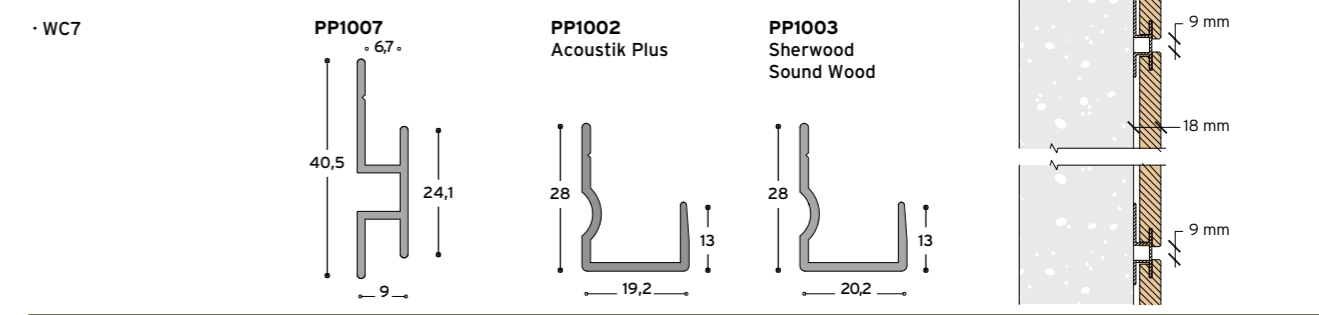

- 1** panel pannello
- 2** M46 / 75 primary support structure struttura di sostegno primaria
- 3** PP1007 secondary profile profilo secondario
- 4** PP1002 Acoustik Plus starting profile profilo di partenza
PP1003 Sherwood Sound Wood
- 5** PPN1 / 40.1 rockwool insulation lana di roccia 600 x 1200 mm

WOOD COVERING 503 SYSTEM



EASY INSPECT



CUSTOM SIZE

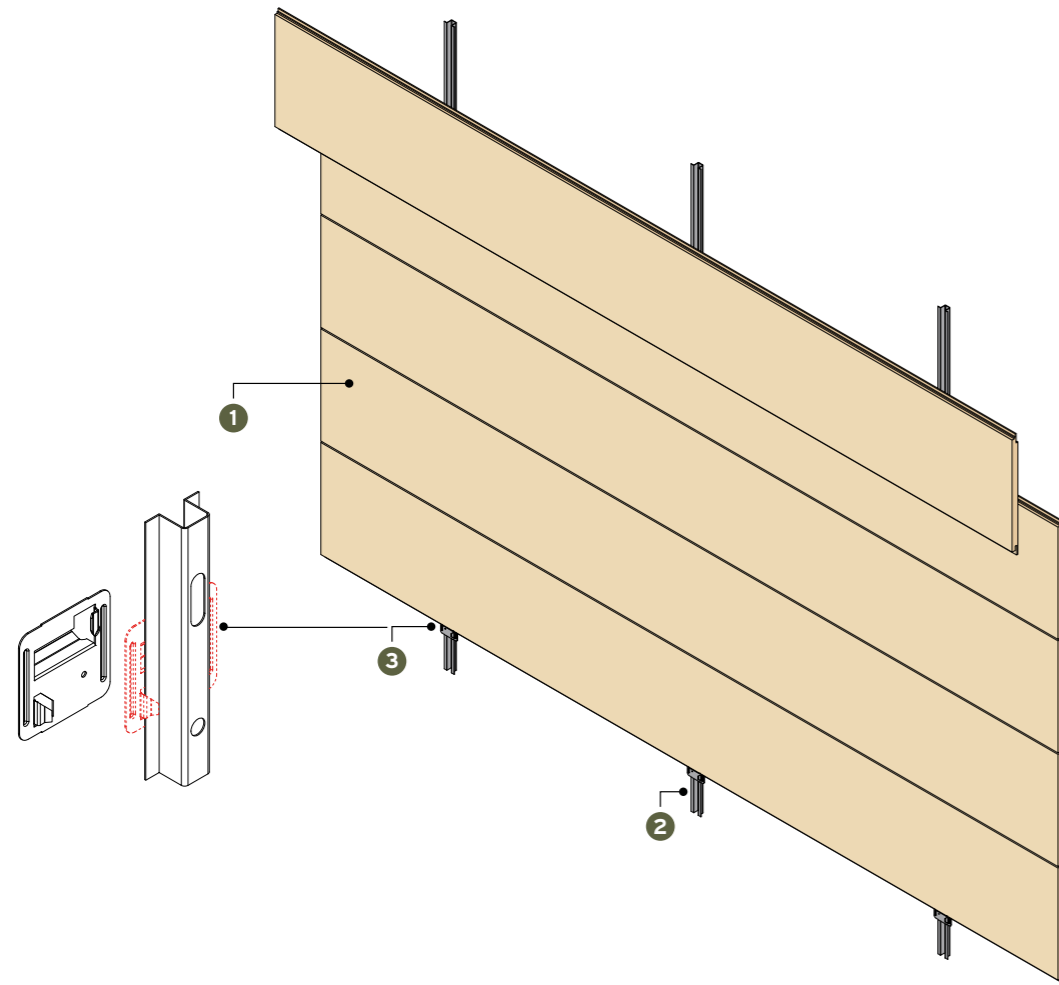

PANEL PANNELLO

dimension type
 square quadrato · SOUND WOOD
 rectangular rettangolare
 custom su progetto

GRID SYSTEM STRUTTURA

· WC2

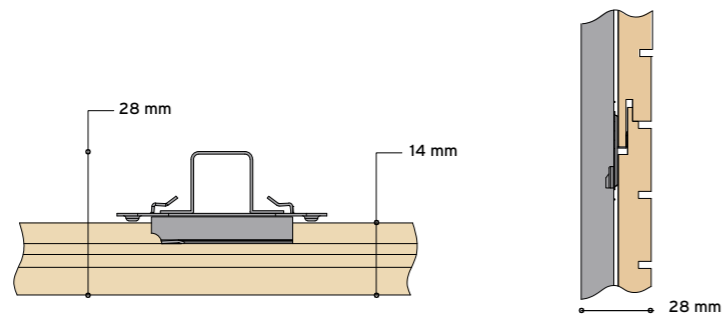

- 1** panel pannello
- 2** PP 1008
- 3** SP76 hidden suspension hook gancio di sospensione nascosto

SOLID WOOD COVERING 504 SYSTEM



100%



SOLID WOOD

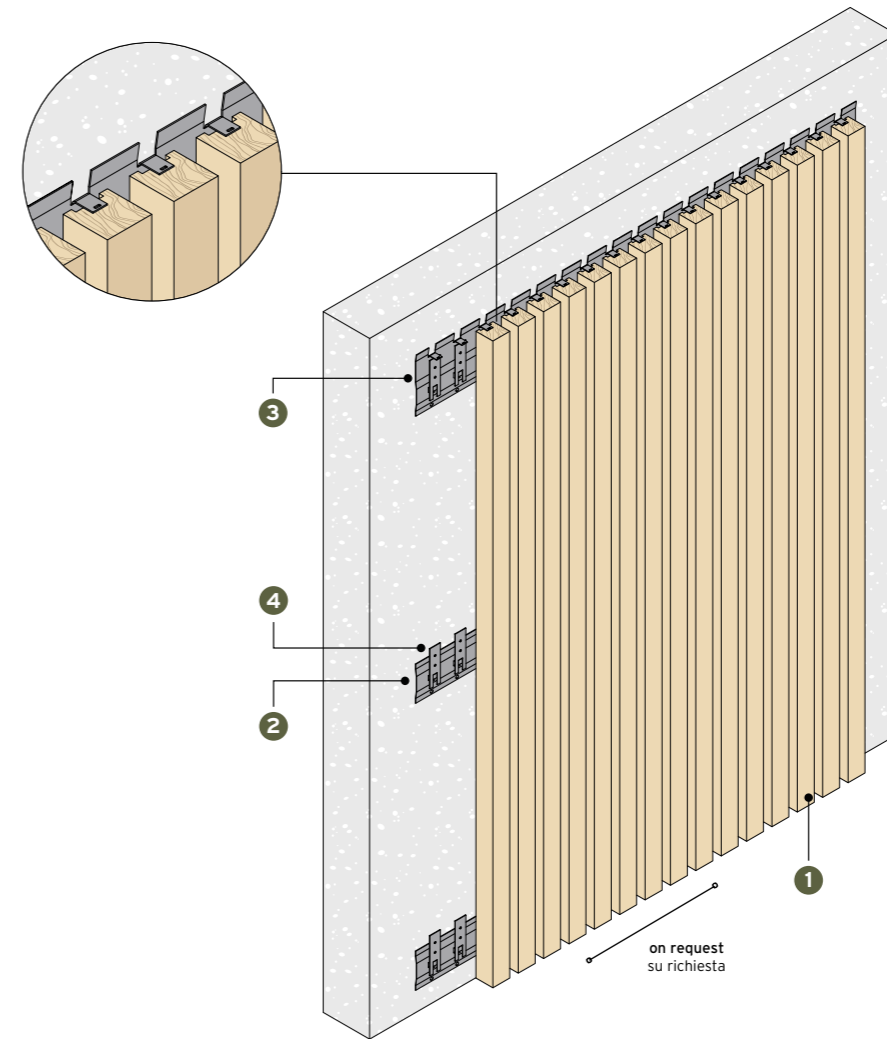

SLAT LAMELLA

dimension type
 H 40/50/60 mm SOLID WOOD
 L 32/40 mm

GRID SYSTEM STRUTTURA

· CWF

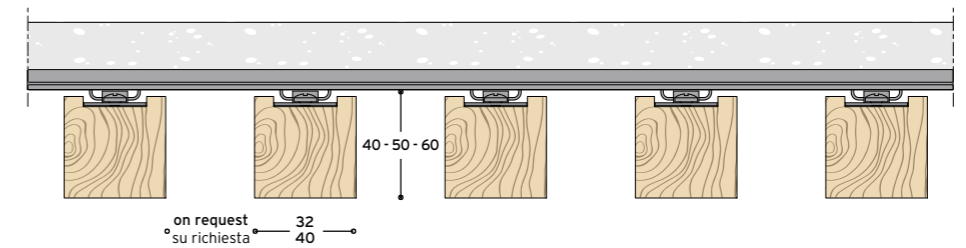

- 1** slat lamella
H 40/50/60 mm
- 2** T 93/N main runner profilo portante
85x4000 mm
- 3** T 93C/N closing profile profilo di chiusura
85x4000 mm
- 4** SP83 connector for slat connettore per lamella

MODULARITY MODULARITÀ

SUSPENDED CEILINGS CONTROSOFFITTI

SHERWOOD ACOUSTIK PLUS
rectangular rettangolare

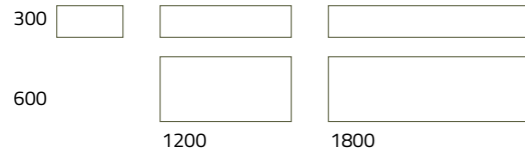

SHERWOOD ACOUSTIK PLUS
square quadrato

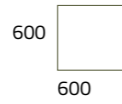

SOUND WOOD



WALL CLADDINGS CONTROPARETE

SHERWOOD ACOUSTIK PLUS
rectangular rettangolare

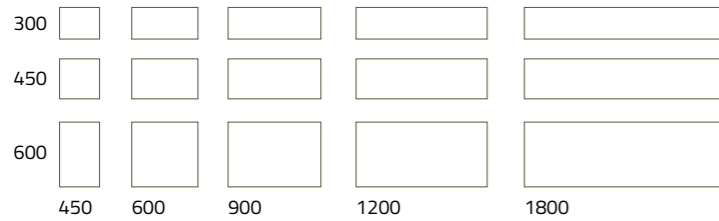

SHERWOOD ACOUSTIK PLUS
square quadrato

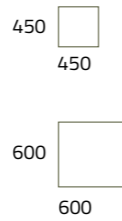

SOUND WOOD

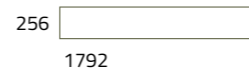

LAMELLA

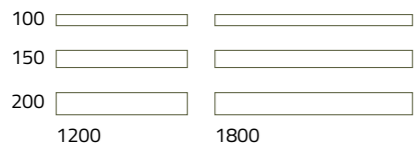

sample compositions · esempi di composizioni

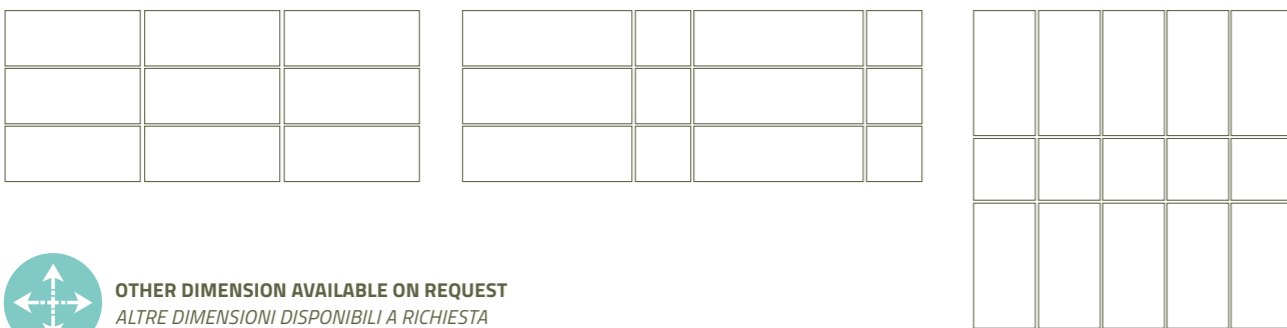
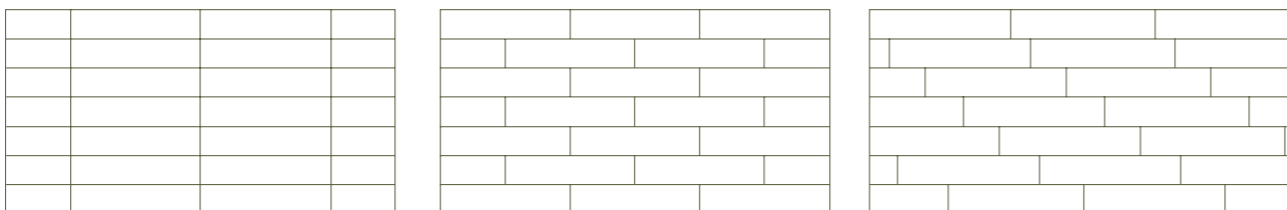

 **OTHER DIMENSION AVAILABLE ON REQUEST**
ALTRE DIMENSIONI DISPONIBILI A RICHIESTA

PERIMETRAL MOLDING CORNICI PERIMETRALI

WOOD EXPO 100

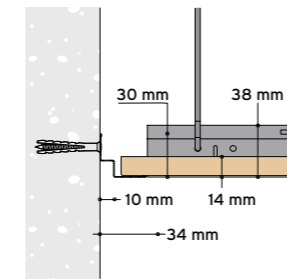

W3000
CWT

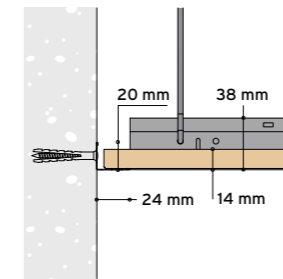

A3000
CWT

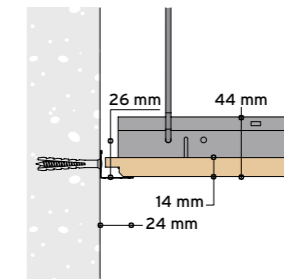

A3001
CWR · CWN

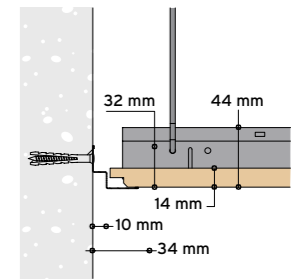

W3001
CWR · CWN

WOOD CONCEALED 200 SYSTEM

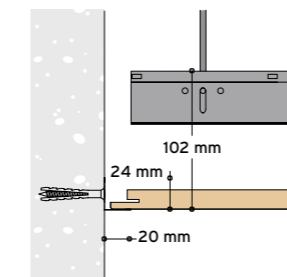

A3000
CWI

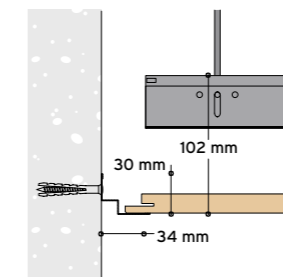

W3000
CWI

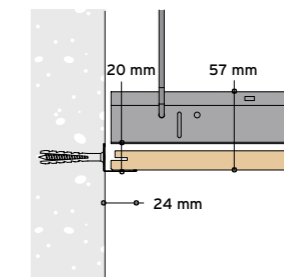

A3001
CWA

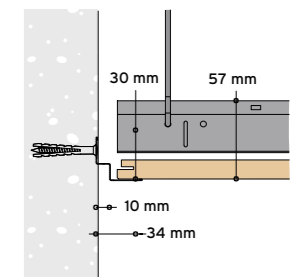

W3000
CWA

WOOD CONCEALED 400 / 401 SYSTEM

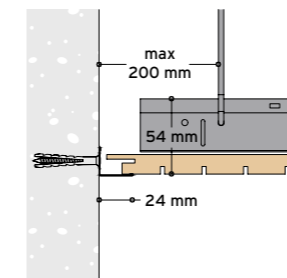

CWB · CWC
A3001

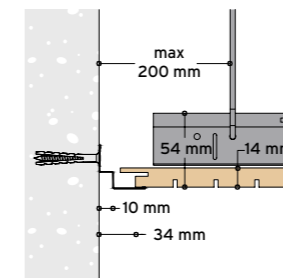

CWB · CWC
W3000

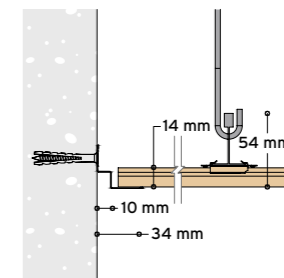

CWB · CWC
W3000

WOOD COVERING 500 / 501 / 502 / 503 SYSTEM

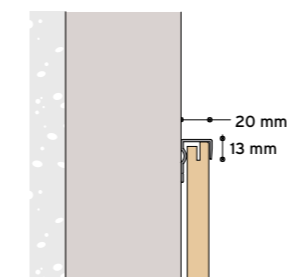

WC1 · WC2 · WC6 · WC7
PP1002 · PP1003

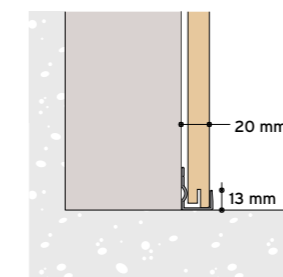

WC1 · WC2 · WC6 · WC7
PP1002 · PP1003

CORNERS ANGOLI

INTERNAL CORNER ANGOLO INTERNO

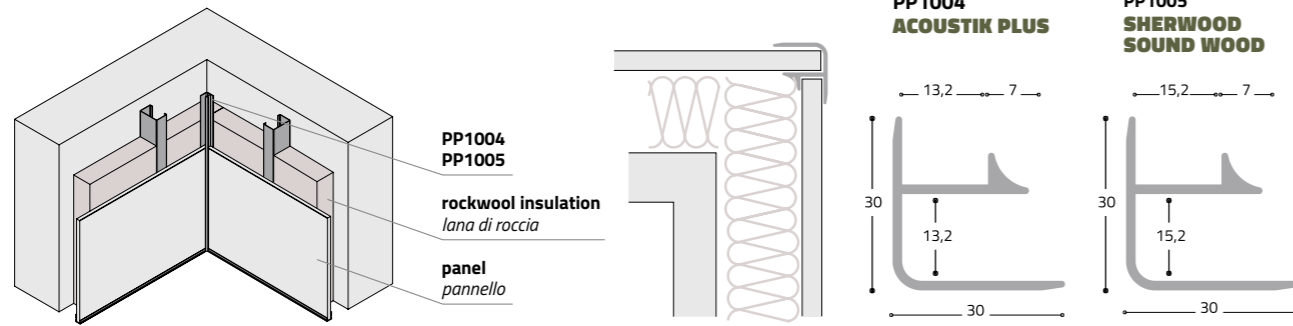

EXTERNAL CORNER ANGOLO ESTERNO

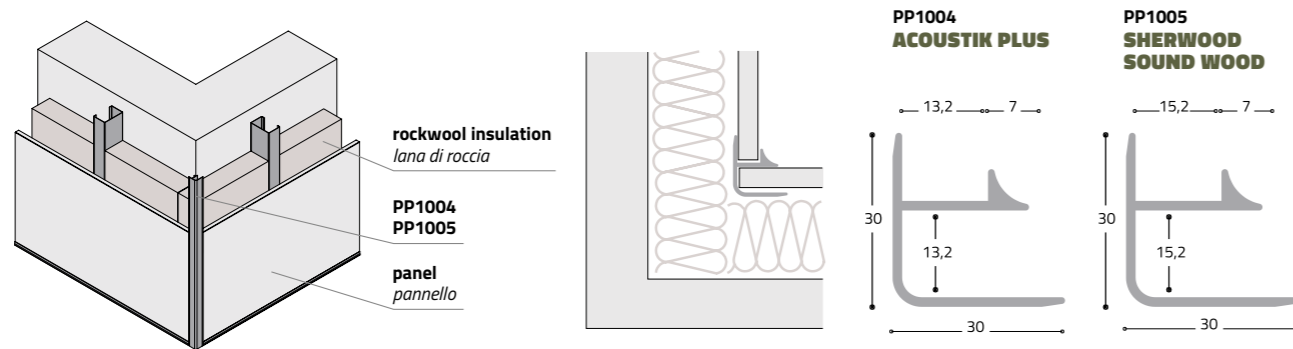

WOODEN CORNER ANGOLO IN LEGNO

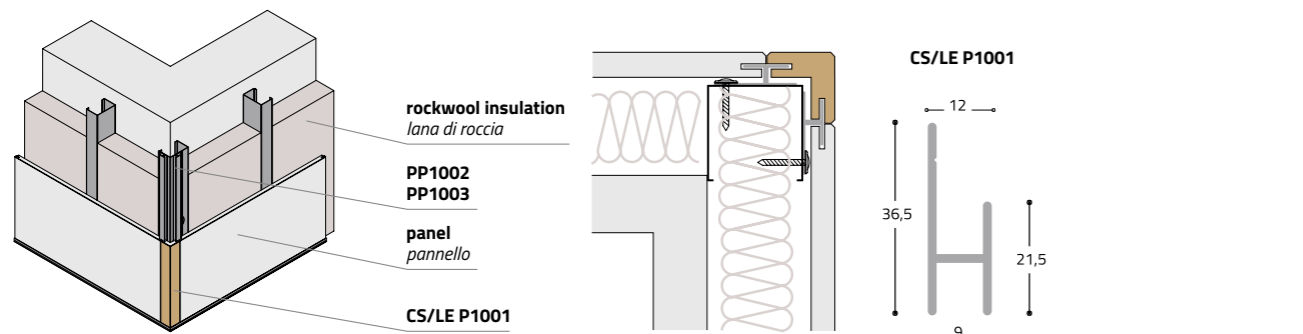

PROFILES PROFILI

LINEAR PROFILE PROFILO LINEARE

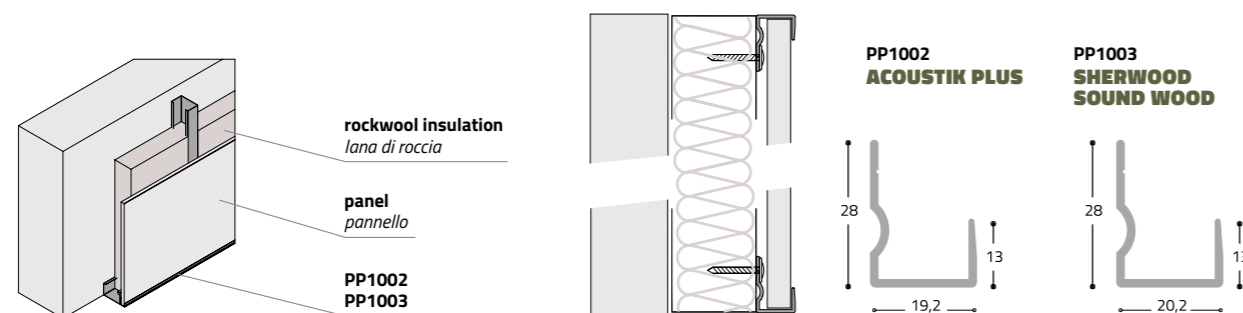

PERFORATION FORATURE



- no perforation *liscio*
- perforation *foratura*
- perforation *foratura*
- ▬ slots *asolatura*

ABC = SHERWOOD · ABC = ACOUSTIK PLUS

F00 · PRO	F01 · PR1 Ø 6 = 2.27 % Ø 8 = 4.03 % ● : 289	F02 · PR2 Ø 6 = 4.28 % Ø 8 = 7.61 % ● : 545
F03 · PR6 Ø 6 = 1.07 % Ø 8 = 1.90 % ● : 136	F04 · PR3 Ø 6 = 4.28 % Ø 8 = 7.61 % ● : 545	F05 · PR4 Ø 6 = 2.01 % Ø 8 = 3.57 % ● : 256
F06 · PR8 Ø 6 = 1.20 % Ø 8 = 2.14 % ● : 153	F07 · PR7 Ø 6 = 2.27 % Ø 8 = 4.03 % ● : 289	F08 · PR5 Ø 6 = 10.17 % Ø 8 = 18.09 % ● : 1296
F09 · PR9 Ø 3 = 2.55 % ● : 1296	A01 · SL1 6x66 mm - 11.00 % 8x66 mm - 14.57 % ▬ : 102	A02 · SL2 6x60 mm - 9.39 % 8x60 mm - 12.43 % ▬ : 96
A03 · SL5 6x66 mm - 10.35 % 8x66 mm - 13.71 % ▬ : 96	A04 · SL6 6x66 mm - 5.18 % 8x66 mm - 6.86 % ▬ : 48	A05 · SL7 6x66 mm - 7.33 % 8x66 mm - 9.71 % ▬ : 68



ACOUSTIC ABSORPTION PANELS
ASSORBIMENTO ACUSTICO PANNELLI

test: Istituto Giordano n° 196088
197140 UNI EN ISO 354: 2003

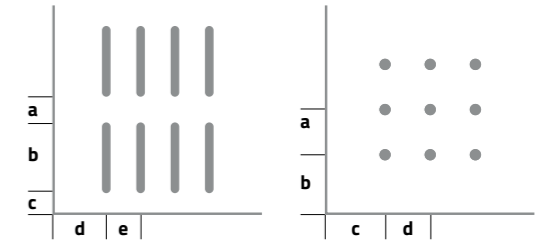

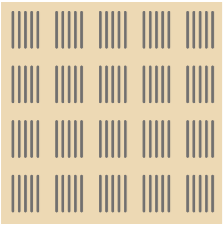
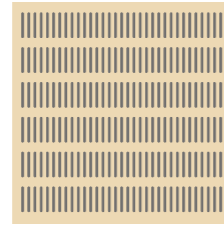
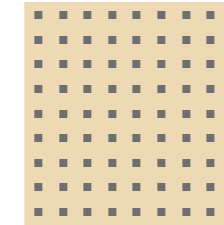
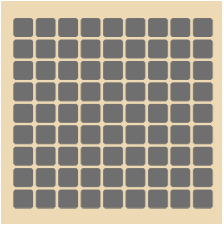
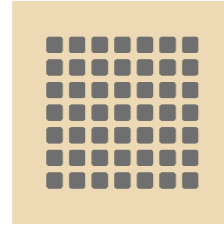
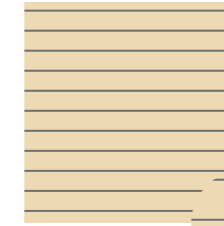
 <p>A06 · SL3 6x96 mm - 15.79 % 8x96 mm - 20.95 % : 100</p>	 <p>A07 · SL4 6x60 mm - 19.37 % 8x60 mm - 25.64 % : 198</p>	 <p>A08 · AD8 20x20 mm = 9.00 % : 81</p>
 <p>A09 50x50 mm = 56.25 % : 100</p>	 <p>A010 40x40 mm = 21.77 % : 198</p>	 <p>A11 spacing larghezza 3 mm depth profondità 2 mm 30 mm</p>

ABC = SHERWOOD · ABC = ACOUSTIK PLUS

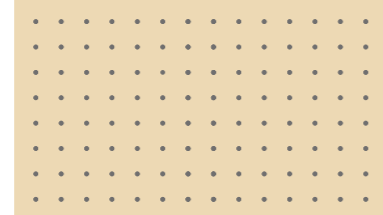
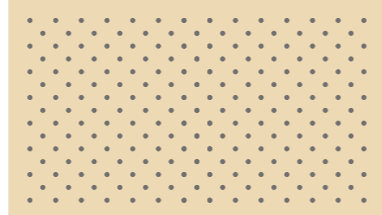
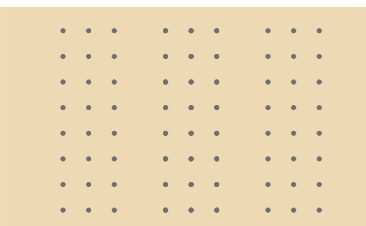
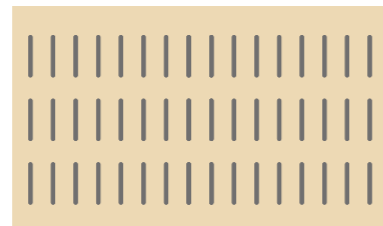
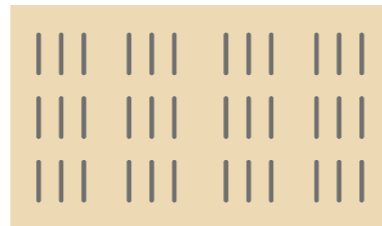
 <p>F00 · DFO 280 x 1200 mm 280 x 1500 mm 280 x 1800 x 14 mm 280 x 2100 x 14 mm</p>	 <p>F01 · DF1 Ø 6 Ø 8 2.49% 4.43% 280 x 1200 mm ● : 296 2.48% 4.40% 280 x 1500 mm ● : 368 2.47% 4.39% 280 x 1800 mm ● : 440 2.50% 4.44% 280 x 2100 mm ● : 520</p>	 <p>F02 · DF2 Ø 6 Ø 8 4.61% 8.19% 280 x 1200 mm ● : 548 4.60% 8.17% 280 x 1500 mm ● : 683 4.63% 8.22% 280 x 1800 mm ● : 825 4.65% 8.27% 280 x 2100 mm ● : 968</p>
 <p>F03 · DF3 Ø 6 Ø 8 1.82% 3.23% 280 x 1200 mm ● : 216 1.94% 3.45% 280 x 1500 mm ● : 288 1.88% 3.35% 280 x 1800 mm ● : 336 1.85% 3.28% 280 x 2100 mm ● : 384</p>	 <p>A01 · CD1 6x66 8x66 mm 12.83% 16.99% 280 x 1200 mm : 111 12.76% 16.90% 280 x 1500 mm : 138 12.71% 16.84% 280 x 1800 mm : 165 12.88% 17.05% 280 x 2100 mm : 195</p>	 <p>A02 · CD2 6x66 8x66 mm 9.36% 12.40% 280 x 1200 mm : 81 9.98% 13.22% 280 x 1500 mm : 108 9.71% 12.86% 280 x 1800 mm : 126 9.51% 12.59% 280 x 2100 mm : 144</p>

ceiling controsoffitto
covering rivestimento

SLOTS ASOLATURA

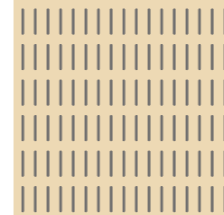

a = 32 mm Ø 6 = 1.07 %
b = 58 mm Ø 8 = 1.90 %
c = 46 mm
d = 44 mm
e = 32 mm

α_p 0,87 | 1,05 | 0,73 | 0,52 | 0,35 $\alpha_w = 0,50$
0,8 0,81 | 0,69 | 0,47 | 0,34 $\alpha_w = 0,50$

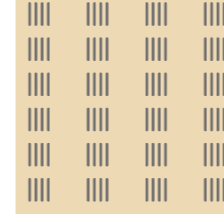

a = 38 mm
b = 52 mm
c = 49 mm
d = 51 mm
e = 16 mm

α_p 0,97 | 0,93 | 0,64 | 0,45 | 0,35 $\alpha_w = 0,50$
0,77 | 0,78 | 0,62 | 0,41 | 0,39 $\alpha_w = 0,45$

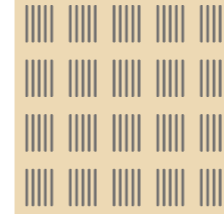

a = 52 mm
b = 88 mm
c = 46 mm
d = 44 mm
e = 16 mm

α_p 0,84 | 1,09 | 0,81 | 0,6 0,47 $\alpha_w = 0,60$
0,89 | 0,84 | 0,83 | 0,6 0,55 $\alpha_w = 0,50$

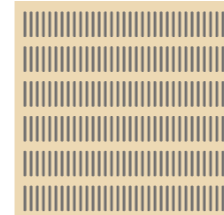

a = 32 mm
b = 58 mm
c = 46 mm
d = 44 mm
e = 16 mm

α_p 0,79 | 1,14 | 0,94 | 0,76 | 0,59 $\alpha_w = 0,75$
0,91 | 0,86 | 0,88 | 0,71 | 0,59 $\alpha_w = 0,75$

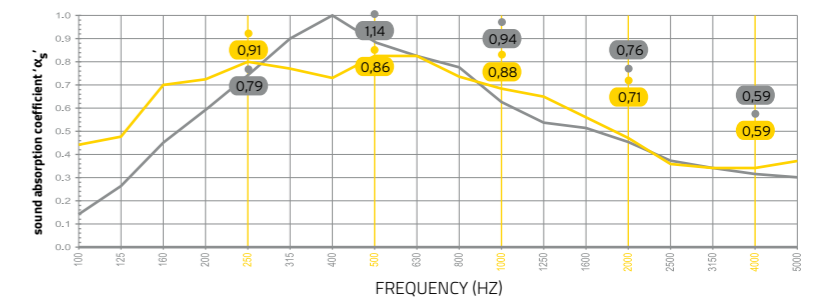
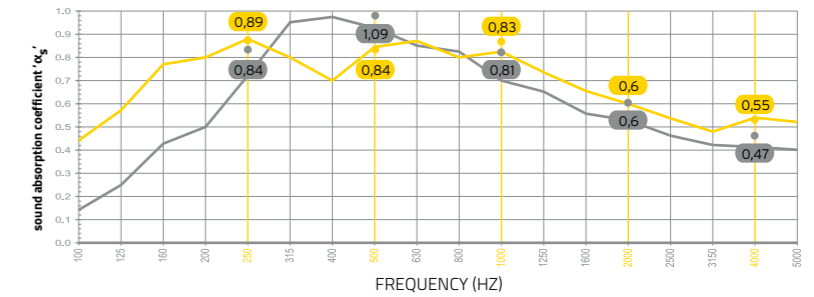
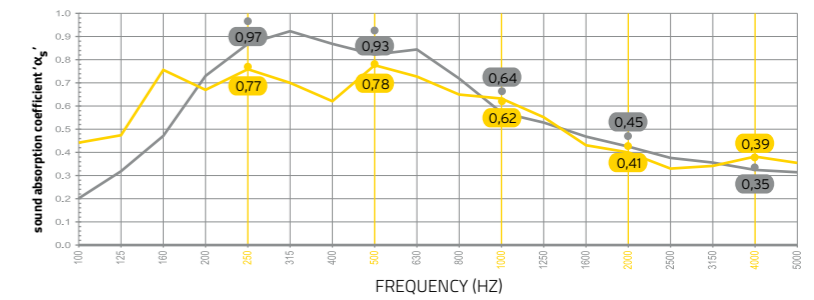
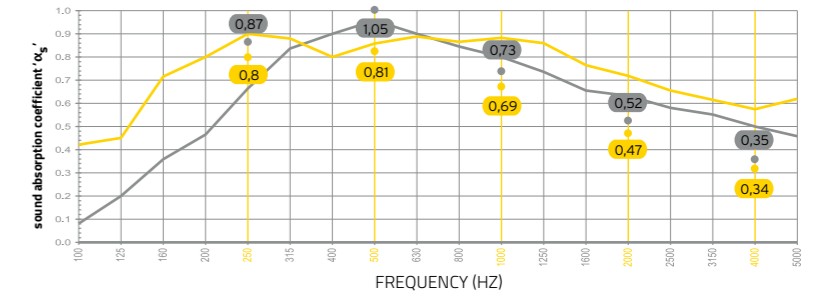

SMOOTH LISCIO



α_p	0,13	0,09	0,03	0,05	0,05	$\alpha_w = 0,10$
	0,06	0,07	0,05	0,02	0,02	$\alpha_w = 0,05$

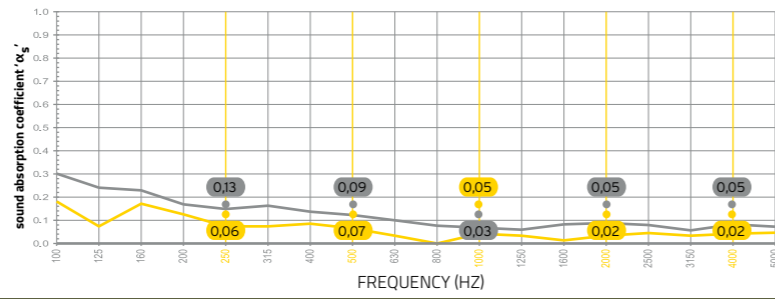

PERFORATION FORATURA

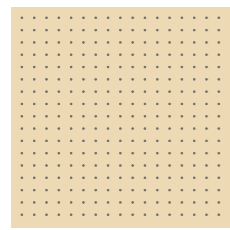

a = 32 mm
b = 44 mm
c = 44 mm
d = 32 mm

α_p	1,01	0,64	0,32	0,18	0,1	$\alpha_w = 0,20$
	0,67	0,57	0,3	0,15	0,13	$\alpha_w = 0,25$

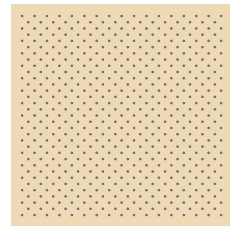
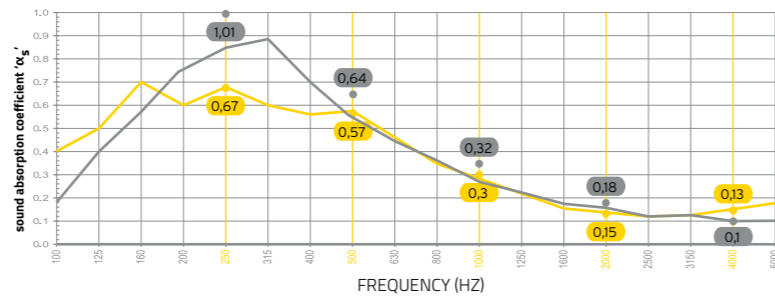

a = 16 mm
b = 44 mm
c = 44 mm
d = 16 mm

α_p	0,99	0,94	0,55	0,32	0,2	$\alpha_w = 0,35$
	0,8	0,78	0,54	0,29	0,19	$\alpha_w = 0,35$

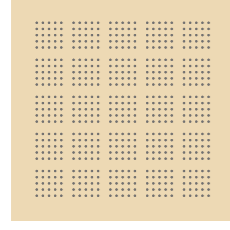
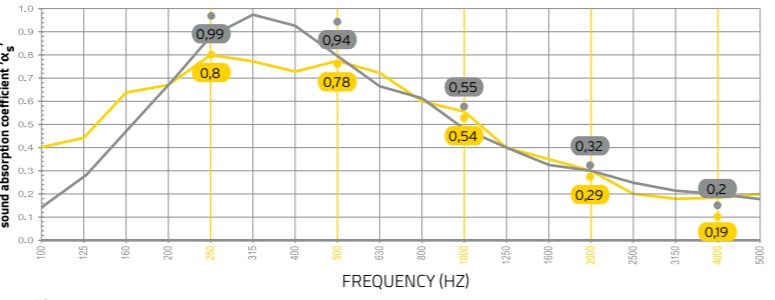

a = 16 mm
b = 76 mm
c = 76 mm
d = 16 mm

α_p	1	0,88	0,59	0,37	0,2	$\alpha_w = 0,35$
	0,75	0,75	0,55	0,32	0,24	$\alpha_w = 0,35$

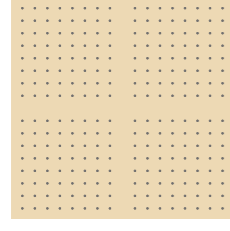
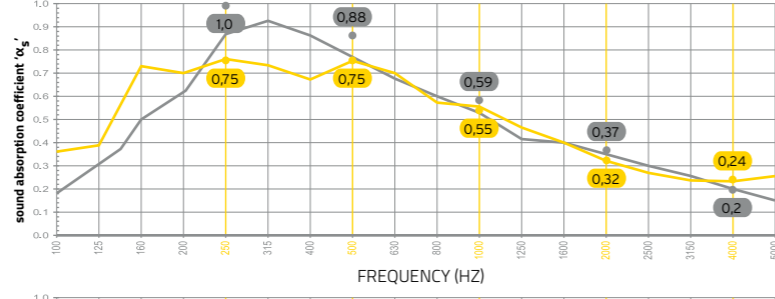

a = 32 mm
b = 44 mm
c = 44 mm
d = 32 mm

α_p	0,98	0,59	0,28	0,16	0,09	$\alpha_w = 0,20$
	0,61	0,56	0,3	0,16	0,15	$\alpha_w = 0,25$

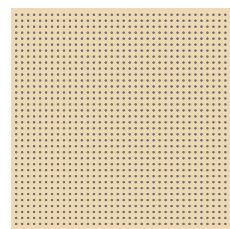
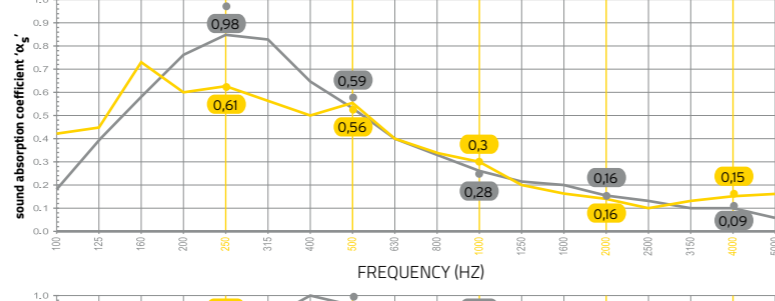

a = 16 mm
b = 17,5 mm
c = 17,5 mm
d = 16 mm

α_p	0,82	1,12	0,87	0,64	0,41	$\alpha_w = 0,60$
	0,88	0,91	0,84	0,63	0,46	$\alpha_w = 0,65$

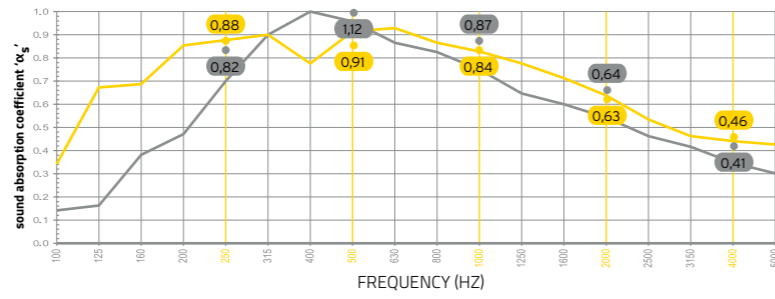

SOUND WOOD PERFORATION - ACOUSTIC ABSORPTION PANELS
FORATURE · ASSORBIMENTO ACUSTICO

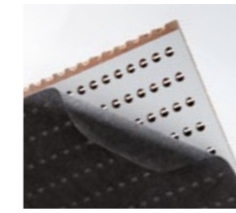

Each element incorporate a layer of sound absorbing material on the panelbacking.
Ogni elemento è comprensivo di uno strato di materiale fonoassorbente sul retro.

ceiling *controsoffitto*
covering *rivestimento*

Istituto Giordano n° 196088
197140 UNI EN ISO 354: 2003

SUPREME SOUND WOOD 1616

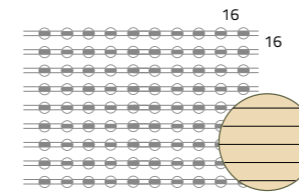

hz	250	500	1000	2000	4000	$\alpha_w = 0,75$
α_p	0,80	0,85	0,90	0,80	0,55	$\alpha_w = 0,85$

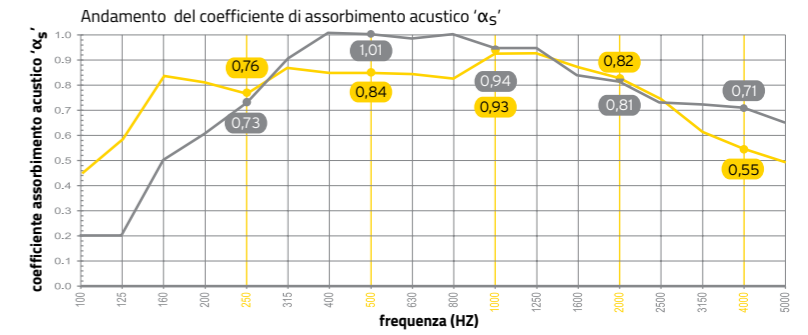

HIGH SOUND WOOD 3216

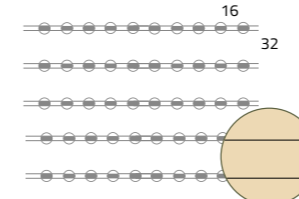

hz	250	500	1000	2000	4000	$\alpha_w = 0,50$
α_p	0,70	0,75	0,70	0,50	0,35	$\alpha_w = 0,55$

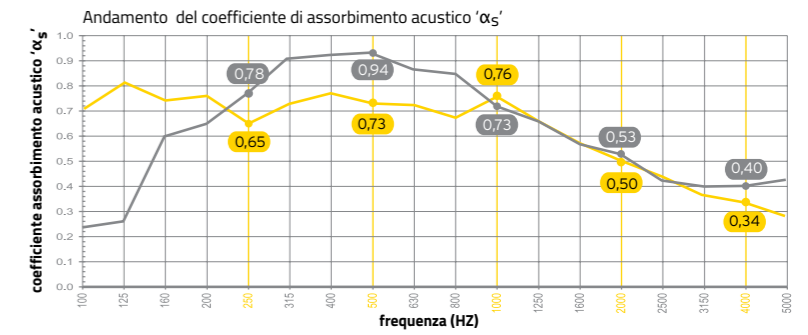

MEDIUM SOUND WOOD 1632

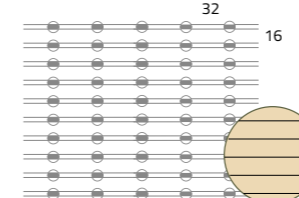

hz	250	500	1000	2000	4000	$\alpha_w = 0,45$
α_p	0,75	0,80	0,75	0,55	0,25	$\alpha_w = 0,65$

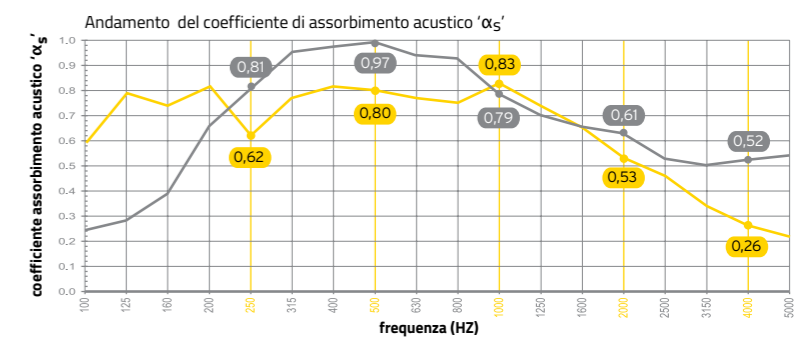

LIGHT SOUND WOOD 3232

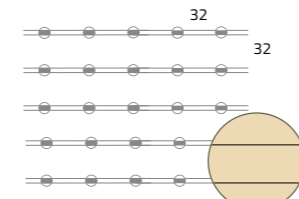

hz	250	500	1000	2000	4000	$\alpha_w = 0,30$
α_p	0,65	0,65	0,50	0,30	0,10	$\alpha_w = 0,40$

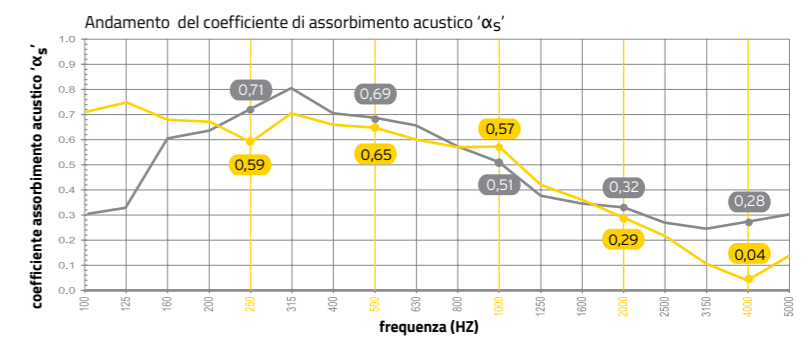

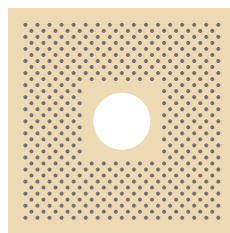
HOLES FOR LIGHTING UNITS FORI PER CORPI ILLUMINANTI

H01
Unperforated internal square
Riquadro non forato

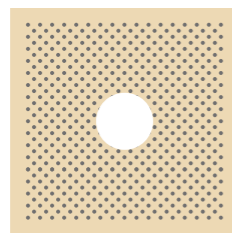

H02
No internal square
Senza riquadro

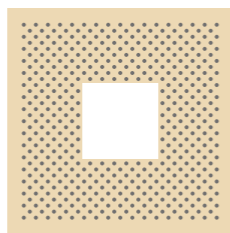

H03
No internal square
Senza riquadro

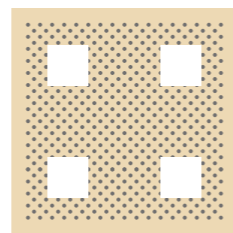

H04
No internal square
Senza riquadro

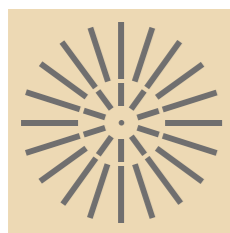
AIR VENTS BOCCHETTE DI AEREAZIONE

H05

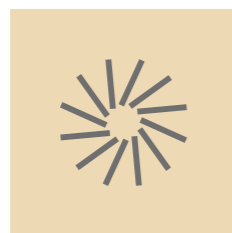

H06

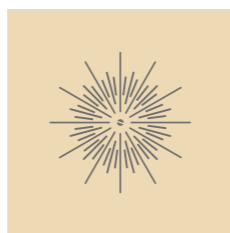

H07

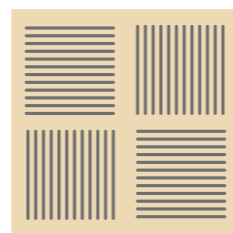

H08

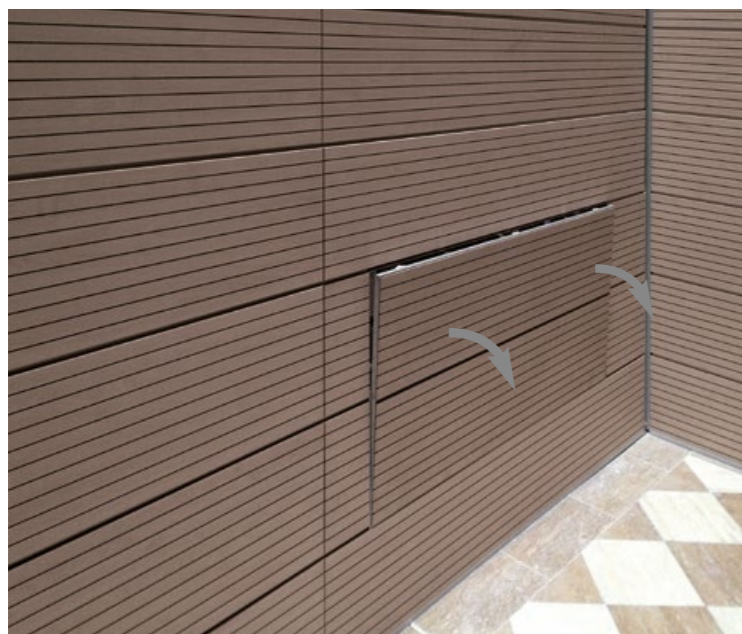
REMOVABLE MANHOLE BOTOLA ISPEZIONABILE**EASY INSPECT**

The manhole is manufactured by CBI Europe - measures on request.

Botola prodotta da CBI Europe misure su richiesta.

FITTINGS ELEMENTI DI SERVIZIO

All Wood System panels permit the installation of fittings such as lighting, air nozzles, fume detectors, sprinklers and suspended signboards.

Tutti i pannelli Wood System consentono d'inserire elementi quali corpi illuminanti, bocchette d'aerazione, rilevatori di fumo, sprinklers e segnaletica ambientale sospesa.

**RECOMMENDATIONS FOR INSTALLATION
RACCOMANDAZIONI PER L'INSTALLAZIONE**

Slight differences in colour and shade between one panel and another are due to natural variations in the wood veneers. To obtain the most pleasing aesthetic effect, we recommend that you lay the panels out before deciding on their final arrangement. It is also good idea to order an extra number of panels to allow for future replacements, since shades, colours and grain can vary from one batch to another. Panels must only be installed in indoor environments when the building maintained at a constant temperature.

Colori e sfumature non uniformi dei pannelli sono dovute alle essenze di legno naturale con cui sono realizzati. Consigliamo pertanto di disporli a vista prima di deciderne la sistemazione finale, così da ottenere l'effetto estetico desiderato. Consigliamo di ordinare un quantitativo supplementare di pannelli in previsione di eventuali sostituzioni, perché tonalità, colori e sfumature possono cambiare di produzione in produzione. L'installazione deve avvenire in ambienti chiusi ed a temperatura costante.

RESISTANCE TO HUMIDITY

Wood System panels should be removed from their packaging in the place of installation 48 hours before installing the ceiling or wall, so that they can assume the humidity of the environment. We recommend switching on the air conditioning in the environment at least 24 hours before starting installation. The installation environment should have temperature no lower than 15° and a relative humidity between 35% and 55% before work starts.

RESISTENZA ALL'UMIDITÀ

Gli imballi dei pannelli Wood System devono essere aperti 48 ore prima nel luogo dove avverrà l'installazione del controsoffitto/rivestimento affinché il materiale raggiunga le condizioni di equilibrio con l'ambiente da rivestire. Consigliamo di climatizzare l'ambiente almeno 24 ore prima dell'installazione in modo che il locale abbia una temperatura minima di 15° con un umidità relativa tra il 35% e il 55%.

HYGIENE AND MAINTENANCE

Wood System panels are easy to maintain and require no special maintenance. To clean, simply wipe with a dry cloth. Panels should not be exposed to direct sunlight: like all natural materials, wood tends to change colour when exposed to UV rays. The polyacrylate treatment of the panels tends to reduce this effect. Remember that water and humidity will damage the veneering.

IGIENE E MANUTENZIONE

I pannelli Wood System sono facili da mantenere. Non necessitano di particolari attenzioni; per la pulizia è sufficiente passarli con un panno asciutto. Consigliamo di non esporre i pannelli alla luce solare diretta: come tutti i materiali naturali, il legno tende a cambiare colore una volta esposto ai raggi UV. La verniciatura UV-poliacrilato con cui sono trattati svolge il compito di limitare questo effetto. Acqua ed umidità deteriorano le impiallaccature.



Having over
35 years of
experience and
a network of
partners all over
the world, allow
us to take care
of the realization
of your complex
construction
projects.

ANGOLA

The Financial City › *Talatona* · Chicalamar Building · Kimpavita Offices › *Luanda*

AZERBAIJAN

Aquatics Center European Games · Offices Business Park · Haydar Aliyev Airport › *Baku*

BANGLADESH

Grameenphone › *Dhacca*

BELARUS

Byelorussian Steel · Works BMZ · Mozyr Oil Refinery MNPZ · Gomeldrev Js · Gomeglass › *Gomel* · Heat station n°5 · National Bank of Belarus › *Neman* · Byelorussian Steel Works › *Zhlobin* · JSC Grodno Azot › *Grodno* · Heat-Electric Generating · The Mobile Telesystems Joint LLC › *Minsk* · Fe Velcom › *Minsk and others cities* · Rue Beltelecom Minsk › *Mogilev and others cities*

BELGIUM

A.G.C. Glas Company › *Gosselies* · Les Portes du Lion › *Waterloo* · Eco Power › *Ham* · Vanreyschoote › *Sint Denijs Westrem* · Zottgem Sanitary › *Zottegem* · Notre maison › *Louvain-La-Neuve* · Connect Immo › *Namur* · ESA › *Redu* · ABN Amro Bank · Antwerp Trainstation · Atlas Copco · MSC Station › *Antwerp* · Ikaros · Diabolo › *Zaventem* · DP World · Antwerp Gateway · European Space Agency · Redu Electrawinds › *Oostende* · Infrabel · Samsonite · *Oudenaarde* · Siemens · Omnicem › *Wetteren* · Krones · L'Oreal · VRT Waterfront offices · Unizo · Cortenberg 107 · Elimo › *Brussels* · Court Of Justice · OTC · Arcelor Mittal · Gerechtsgebouw › *Ghent* · Telenet › *Mechelen*

BULGARIA

Vision Hospital › *Sofia* · Biovet JSC › *Peshtera* · Municipality of Dalgopol · Sports Hall · Varna Airport › *Varna* · Devnya Cement › *Devnya* · Info center · Grawe Office Building › *Sofia*

CROATIA

Ict King Buzin · Immorent business center Instrumentarija business center › *Zagreb* · Imobilia Tehno Iii & Iv · Otok M-San residential and business center › *Rugvica* · Komunalac business center › *Samobor*

CYPRUS

Tsys Offices At Annex · Trust Building › *Koustais* · Demetra Ependitiki · Panicos Nicolaides Offices Consulco Project · Rik · Crestpoly Building · Cyta · Shiacolas Elmeni Cycleair H&D · Mavrommatis building · Renaissance · National health services · Nicolaides building · Air Control Building · Hadjihannas · Alpha Bank · Popular Bank · Hellenik Bank · Jcc Credit Card · Clearance Centre · Rai Consultants · Stock Exchange Market University Of Nicosia Water Board Department A.G. Papaellinas Offices · Land Registry Of Nicosia · General Hospital · Cyprus Telecommunication Authority · Zefix › *Nicosia* · Lofitis Business Center › *Medstar* · Interorient › *Limassol* · Larnaca Airport · Laiki popular bank · Aek offices Insurance Company Of Popular Bank · Popular Bank District Office Agios Iazaros › *Larnaca* · Electricity Authority Substations › *Platres and Nicosia* · Athinodorou Business Centre › *Paphos*



Campus Palmas Altas · Seville, Spain

The first building in Europe to be awarded the PLATINUM LEED certification in 2009

ANGOLA
AZERBAIJAN
BELGIUM
BULGARIA
BANGLADESH
BELARUS
CROATIA
CYPRUS
EGYPT
EQUATORIAL GUINEA
ESTONIA
GREECE
HUNGARY
ICELAND
IRAQ
IRELAND
ITALY
JORDAN
KAZAKISTAN
KUWAIT
LATVIA
LEBANON
LITHUANIA
MALTA
MEXICO
MOROCCO
MOZAMBIQUE
NEW ZEALAND
NIGERIA
PAKISTAN
PORTUGAL
QATAR
ROMANIA
RUSSIA
SAMOA
SAUDI ARABIA
SERBIA
SLOVAKIA
SLOVENIA
SPAIN
SWITZERLAND
TUNISIA
TURKEY
UAE
UKRAINE
UNITED KINGDOM
UNITED STATES
YEMEN



The Mark Office Tower · Bucharest, Romania



Qatar Olympic Sport Museum Qosm At Khalifa Stadium · Doha



Mill Park Cognizant offices · Budapest, Hungary



Japanese University · Alexandria, Egypt



Memorial Hermann Medical Plaza · Houston, USA



Openville · Timisoara, Romania



Coop hypermarket · Terni, Italy



Aston Building · Košice, Slovakia



Officine Garibaldi · Pisa, Italy



Equilibrium Office Tower · Bucharest, Romania



Hotel Hilton · Tallin, Estonia



Comune di Livorno · Livorno, Italy



Conad hypermarket
Ancona, Italy



EGYPT

Japanese University · Edf Electricità De France · Alexandria · Mercedes-Benz Showroom El Dokki District · Media Production City · Administrative Premises for Egyptian Banks Company (EBC) · Egyptian General Intelligence · Milks Company · National Egyptian Bank · Burj Al Arab Branch · Arab Investment Bank · Minya Governorate Branch Arab Investment Bank: 5th District Branch, Al About District Branch, Al Arab Mall Branch 6th October City · Export Development Bank of Egypt · Shobra District Branch · Ahly United Bank · Bloom Bank · Cairo Airport · Cib Bank · Cairo · Marsa Matrouh · Hurghada · Aswan Sport Stadium · Aswan City · Nile Sat Extension Building · October City

EQUATORIAL GUINEA

Sipopo Congress Center · Malabo

ESTONIA

Conference center Maakri tn.19 · Hotel Hilton Strategic Communication Centre · Hansapank Server Building · Tallin

GREECE

Cosmote office building · OPAP office building · Aspropyrgos office building · Dol office building · Glyfada office building · Opera House · Eurobank Head Quarter · Regency Casino Mont Parnes · S&B Industrial Minerals S.A. Tennis Pavilion · Olympics 2004 Yamaha Building · Athens · Opera House · Technical School Of Kalamaria · Thessaloniki

HUNGARY

Promenade Garden offices · Mill Park Cognizant offices · Budapest

ICELAND

Isavia Airport authorities · Orkubú Vestfjarða Ossur head office · Mjólkursamsalan company Ríkisútvarpið · State Television Lýsi hf · Íshúsfélag Vestmannaeyja plant Municipal office in Greenland · Reiknistofa bankanna · IT service head office · Íbúðalánasjóður · Housing Financing Fund office · Bp Head office · Reykjavik

IRAQ

Çalik Holding

IRELAND

Langan Quay Office Development · Belfast · Cherrywood Block F · Shop On Liffey Street · Dublin · City Gate Business Center Mahon · Cork · City Square shopping centre · Student Accomodation Waterford Institute · Waterford

ISRAEL

Galil Medical · Boston Scientific BTG Group Offices · Yokne'am Illit

ITALY

Sala Asia Poste Italiane · Palazzo di via del Serafico 200 · Palazzo Italia · Pontificio Collegio Americano in Vaticano · Nuova stazione Tiburtina · Banca Popolare di Vicenza · Roma · Sede Amazon · Bosch Italia Siderurgica Latina Martin Spa · Gesa Vending · Milano · Istituto Zooprofilattico Sperimentale Sige Spa · Ancona · Sala Danza Liceo Pascal · Pompei (NA) · Cejn Italy · Sesto San Giovanni Unigrà Srl · Conselice (RA) · New Efore · Osimo · Coop · Terni · Conad · Pescara · Centro Polifunzionale di Campotenesse · Parco del Pollino Calabria · Comune di Livorno · Ufficio Anagrafe · Livorno · Officine Garibaldi di Pisa · Pisa · USL Teramo · Teramo · Hops! birreria F.lli Simonetti Spa · Civitanova Marche · Teatro Acca · Montella · Nuovo Auditorium · Camposanpiero (PD) · Istituto Patriarcale del Vaticano · Venezia · Enel Spa · Energy Resources · Jesi · Ferrero Spa Office Building · Alba · Infissi Design · Treia · Elerico Home · Recanati · Liomatic · Rieti · Colonna Park Hotel · Porto Cervo · Studio Brunetti e Catanossi · Sistema Edilizia Perugia · Scai · Perugia · Hotel Le Grotte · Genga (AN) · Pineta Hotel · Monsano (AN) · Villa Rugani · Siena · CPF Costruzioni SPA · Firenze · Marcelloni · Terni · Cepu · Villaggio Olimpico Sestriere · Lavazza Spa · Torino · Serrature Meroni · Lentate sul

Seveso (MI) · Glem Gas · Modena · Associazione Industriali · Reggio Emilia · Customs offices port · La Spezia · Colonnara Park Hotel · Porto Cervo Security Offices · La Spezia · Findomestic · Assilichi Spa · Firenze · Novartis Spa · Siena · Sandy caffè · Arezzo · Ufficio Anagrafe · Pistoia Interporto · Chieti · Bacchicocchi · Somacis Group · Castelfidardo (AN) · Banca d'Italia · Terni Camera di Commercio · Lucca · Piaggio Spa · Pontedera · Ospedale di Todì · Todì · Office Development · Pisa · Fellowes Leonardi Spa · Camerano (AN) · Elica Spa · Fabriano · Ferro Adriatica Spa · SMA Rinascente Group · Osimo Agroalimentare Monaldi Spa · Ascoli Piceno · Cartechini Argenterie · Corridonia (MC) · Bieffe Spa · Sapore di Mare Spa · Macerata · Cort House Office · Tolentino (MC) · Di.Ba · Pesaro · Cepu · Città di Castello (PG) · Hospital of Andria · Andria (BA) · Banca Popolare · Università di Bari · Bari · Università di Foggia · Foggia · Antonio Capaldo Spa · Avellino · Oleificio Rocchi · Lucca · Azienda Ospedaliera Rummo · Benevento · Enel · Caserta · Futura Line Industrie · Alenia Spa · Capodichino Airport · Centro Commerciale CIS Centro Commerciale Mandi · Corallo Oromare Project · Poste Centrali · Il Tarì Project · Intesa Bank · Napoletanagas Spa · Porto di Napoli · Sanpaolo IMI Bank · Alenia Spa · Regione Campania · Tribunale · Uffici Inail · Napoli · Telecom Spa · Palermo · Università di Fisciano · Salerno · Ospedale di Matera · Matera · Call Centre · Enna · Life Guard · Catania · Azienda Ospedaliera Papardo · Messina · Base Nato · Sigonella (CT) · Tribunale di Siracusa · Siracusa



Cosmote head quarter, Karela Office Park · Paiania, Greece
The first building in Greece to be awarded the Gold Level of LEED certification in 2013

JORDAN

Telecom › *Shaban* · Crowne Plaza Dead Sea Resort › *Swemeh* · Arab Islamic Bank Jordanian–Syrian border–Jabber · Army Financial dept · Housing Bank · Communication board › *Amman* · Mafrag Military Hospital › *Al Mafrag* · Housing Bank › *Salt Gate & Aqaba Br.*

KAZAKHISTAN

Astana Expo 2017 · KazMunayGas › *Astana* Almaty Metro › *Almaty* · Broadcast relay station › *Semey* · Kaztelradio › *Ridder*

KUWAIT

Kuwait National Petroleum Company › *Al Ahmadi* · The Training Vocational Institute for Girls › *Al-Jahra* · Kuwait National Guard · Kuwait Institute of judicial & Legal Studies Wataniya HQ · KIPCO Tower · KOC Fire Station · Ministry of Health · PAAET project Arabization Medical Center · KISR Admin building · KOTC Building · Ministry of Public Works › *Safat* · Khlijia Tower Gulf Consult · New Japanese Embassy · Mushrif · Middle East Digital Communication · Symphony Complex Project › *Salmiya* · Mubarakiya Tower Kuwait Airport · Kuwait University · Khlijia Tower · Gulf Consult · Koc · Kuwait Oil Co. Artaal Office Project · Al Bahar Tower Al Dhow Tower › *Kuwait City*



Famfa Oil Tower · Lagos, Nigeria

Swan Office Park · Bucharest, Romania
Winner of the RoGBC Green Building Project of the year award · 2011**LATVIA**

Riga Forest School · International Airport › *Riga*

LEBANON

Future TV › *Beirut*

LITHUANIA

Eika Business centre · Green Hall 2 · Baltijos Gildija · Apranga Office · Ainava Project Problematika Project · Park Town · The Museum Of Genocide Victims › *Vilnius* Magnum business center · Kauno Dokas · Shopping center Molas · Business Centre 349 › *Kaunas*

MALTA

Life Sciences Park › *San Gwann* · Malta Information Technology Agency (MITA) › *St Venera* · Wurth New Premises › *Zebbug* · Vodafone Offices · Aps Bank › *Swatar* · Melita Cable Plc › *Madliena* · The Point Commercial Centre › *Tigne* · University Of Malta · ICT Faculty Building › *Msida* · Go Plc › *Marsa* · Connection Café · Malta International Airport · Malta Air Traffic Control (MATS) › *Luqa*

MOROCCO

Morocco ONE · Marine Royale · Direction des statistiques › *Rabat* · OCP Group › *Safi/ Youssoufia* · Amendis › *Tétouan* · Sevam › *Casablanca* · Jeers Industrie /Novatis Group › *Berrechid*

MOZAMBIQUE

Eni Headquarter › *Maputo*

NEW ZEALAND

Half Moon Bay · Kingsway College · Pakuranga Library · Birkenhead Library · Botany Clinic Albany Office Park · St Margaret's College · Unitec Institute of Technology · Extreme › *Auckland* · Christchurch Hospital › *Christchurch* · Alpha Pharmaceuticals › *East Tamaki* · Cameron Road › *Tauranga* · Furniture City · City Fitness Hamilton · MOE › *Hamilton* · City Motor Group · Gilmore Brown › *Whangarei*

NIGERIA

Famfa Oil Tower › *Lagos* · CBN Central Bank of Nigeria · Head quarter › *Abuja*

PAKISTAN

Office Complex › *Karachi*

PORTUGAL

Miranda Law Firm › *Lisbon* · Casa da Calçada Hotel › *Amarante* · PNB Building › *Braga* · Royal Óbidos Spa & Golf Resort › *Óbidos* Casfil Headquarters › *Santo Tirso* · Trielle

Offices › *Aveiro* · Enviroil Offices › *Chamusca* Tecmaia · Science and Technology Park › *Maia* Project Raeye · Atlantic Network of Geodynamical and Space Stations › *Santa Maria, Azores* · Novo Banco – Agencies › *Coimbra and other cities* · Fidelidade Insurance · *Lisboa* · Gaia City Hall · Data Center › *Gaia* · Borgwarner Production Plant › *Viana do Castelo* Edp Ribeiradio – Ermida Dam › *Sever do Vouga* · Ctt Post Office › *Coimbra* · Epimetheus Offices · AVIZ Building Porto Business School National Union of Bank Employees · *Sã Carneiro Airport* › *Oporto* Portucel · Data Center › *Figueira da Foz* · Nato Operational Command · Data Center › *Oeiras*

QATAR

Lusail Office Tower (COM 18) · Qatar Olympic Sport Museum Qosm At Khalifa Stadium · Qatar Petroleum District Qpd Tower 10 Noc Tower · Qibb Qatar International · Islamic Bank Gulf Mall Building › *Doha* · Qatar Petroleum hoffice · Al Samerya Tower Le Mirage Hotel Beach House · Urbacon Co. Head Office · MOI Criminal Department · Al Duhail Police Complex · QP Main Serve Room Abu About Area · Living In Car ShowRoom · Industrial Area · Ooredoo Office · 14 Sever & Qtel Rooms Guard House at Qatar University · Gulf east trading & contracting West bay Area · Al Faisal Tower · Qatar University · Room lekhiya stadium · Qatar General Insurance World Trade Center Tower · QP Tower · Club House Al Wajba › *Dukhan Area* QGIRCO Branches at Murra & Al Khore area Project › *Al Khour*

ROMANIA

Tiriac Tower Buzesti Olympic Swimming Pool Project · One Tower One Floreasca City · Equilibrium Office Tower The Mark Office Tower · Campus 6.2 6.3 · Campus 6.1 Office Tower · Stefan cel Mare Building · AFI Business Park · Interio Eurobank · HP Hewlett Packard · Kandia Chocolate Factory · Piata Vitian · Dagesh Group Constructi · General Construct · Swan Office Park · Cascade Park › *Bucharest* · Openville › *Timisoara*

RUSSIA

Airport Kurumoch › *Kazan'* · Mission Control Center › *Korolev city* · Lesoparkovaya metro station · Park Pobedi metro station · Zhulebino metro station · Yandex Office · Silver City Project · Panasonic · Rosnano Office · Yandex Office › *Moscow*



Lusail Office Tower (COM 18) · Lusail, Qatar



Magnum business center · Kaunas, Lithuania



University of Nicosia · Nicosia, Cyprus



Aquatics Center, Baku · Azerbaijan



Nestlé E2V · La-Tour-de-Peilz, Switzerland



Qatar Petroleum, WTC · Doha



Office Biovet · Peshtera, Bulgaria



International Airport · Riga, Latvia



Noc Tower, Qiib Qatar International Bank · Doha



Queen Mary University · London, UK



New line 9 metro · Barcelona, Spain



Astana Expo · Kazakhstan

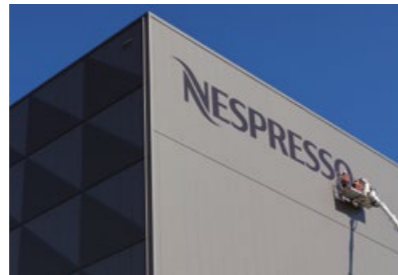

Nespresso · Romont, Switzerland

Conference center, Maakri · Tallin



Sipopo Congress Center · Malabo, Equatorial Guinea



Uffici Inail · Napoli, Italy



Nuova stazione Tiburtina · Roma, Italy Doha



Tiriac Tower Buzesti · Bucarest, Romania



SAMOA

Bank of Samoa H/O · Apia

SAUDI ARABIA

Faculty of Science College · Support Academic area · National Guard · Mobily offices · Argaam 3M Offices · Nat · Pfizer · Souq.com · Riyadh Bank · Deanary Building Imam University · ANB Bank · Riyadh · Transportation building · Qassim University Dental college · Qassim Bureda · Ksa · NT3 Naval base · Jeddah · Ksa · Girls college Al Khabji · Girls college Nariyah · Dammam University · Dammam · Ksa · Qassim University · Riyadh · Pfizer Offices · Jeddah

SERBIA

Municipality of Rakovica · Belgrade · FIAT · Kragujevac

SLOVAKIA

Aston Building head quarters · Offices Buiding · Kosice

SLOVENIA

Eda center · Nova Gorica

SPAIN

Instituto de Enseñanza les Reus · Tarragona International Airport · Valencia · New line 9 metro · Illacuna New Business Park · Design Center Library · Vopi · Barcellona Girona University · Girona · Campus Palmas Altas · Tecnology Park Palmas Altas · Sevilla Alei Center Office Complex · Malaga Maillorca Hospital · Maillorca · Banco Mare Nostrum (Bmn) Caixa Penedes · Corporate headquarters Expansion · Vilafranca

SWITZERLAND

CEJN Ag · Swiss headquarters · Cham · Nestlé E2V · La Tour-de-Peilz · Nespresso · Romont STG Creation Precigems · Satigny · UBS Rhône · Rolex Offices · Geneve

TUNISIA

Tunis Carthage International Airport Tunisiana · Orange · Tunisie Telecom · Siemens · STEG · Ekon · Carthage · Tav Aéroport Hammamet Enfidha · Aéroport de Monastir · Carrefour · Henkel · Total · Tunisi

TURKEY

Yildirimlar Holding · Akplaza Istanbul Municipality · Isbank New Head Quarter Çalık Holding Irak · Anadolu insurance headquarter · Yapı Kredi Plaza · Vodafone Tuzla Mtx Building · Tekfen · Levent Office Building · Tfbk Bank · Tophane Center

Management Building · Turkish Ground Forces · Yıldız Teknik Üniversitesi Davutpaşa Teknopark · Mercedes Benz · Bosch Termoteknik Genel Müdürlüğü · Simeks · Garanti Koza · Nt Headquarter · Opet Genel Müdürlüğü · Helis Metro Yapı · UTS Makine Kalıp Yönetim Binası · Doğuş Teknoloji; Kristal Kule · Tekstilbank Genel Müdürlüğü · Anadolu Sigorta Genel Müdürlüğü · Çalık Holding Iraq Borsa Istanbul Data Center · Metro Gross market · Vodafone · T.B.M.M. · Peugeot Genel Müdürlüğü · Herball Life · Vodafone Esenyurt Garanti Bankası · Eczacıbaşı · Tnt · Akfirat

Çalık Holding A.Ş. · University Of Economy · Izmir · Tekfen Office Building · Kağıthane Mercedes Benz · Bahcesehir · Aksaray / Hoşde-re Management Building · Doğuş İnşaat Ayazağa/Istanbul · Çalık Holding A.Ş. · Irak Power Plant · Bosch Çerkezköy · Garanti Bankası · Kredi Kartlar Birliği · Tübitak Uekae Yk Bank · Yapı Kredi Plaza/Banking Base · Clariant · Yapı Kredi Bankası · Atatürk Airport · Institute of Technology Turkcell · Gebze

UKRAINE

IQ Business Centre · Kiev



One Tower · One Floreasca City · Bucarest, Romania

Holding Building · Hurriyet Media · Maslak · Haci Omer Sabanci Holding · Ibm · Eczacibi Yıldız Tekno Park · Tskb Bank · Asja Bank · Avea Telecom · Garanti Koza · Koza Plaza Kutuk Mermer · Renault Bursa · Istanbul Turkcell Data Center · Beyoğlu · Akbank Departments (All over Türkiye) · Tskb Bank · Tophane Bepaş (İstikbal & Bellona) Garanti Bank Branch Over Turkey · Tnt Management Building · Ümraniye · Silkar Holding Building Bayrampaşa Zorlu Center · Eczacıbaşı · Levent Istanbul · Tfbk Bank · Kartal General Management · Yıldız Teknopark · Davutpaşa Campus · Vodafone TuzlaMtx Building · Yeşilköy Airport Tekyapi Tekyapi Vodafone Esenyurt Anel · Mtx Building Ergo · Hp · Ümraniye · Bosch · Çerkezköy Diem · Bsh – Kartal · Tekstil Bank Küçükalyi · Aktürk Zorlu Project · Levent · Tekfen · Kağıthane Building Yeni Teknik Yapı · Bosch General Management Building · Kare It Systems · Avea Güneşli · Dogan Engineering · Elaziğ Airport · Gürsel Transport · Kartal Management Building ·

UAE

Ruler's Court · Emitac Mobile Solutions Ilc · International City · Gate Village · Mercantile Exchange · Philip Morris · Dubai · National Chemicals Co Chemawajaat Offices · Company for Onshore Oil Operations · ADCO Offices · Abu Dhabi

UNITED KINGDOM

Queen Mary University · London

UNITED STATES

Memorial Hermann Hospital · Langham Creek YMCA · Federal Reserve Bank · Jacobs Engineering · Rice University Autry Courts · Ten West Corporate Center · Texas Children's Hospital West Campus · Memorial Hermann Medical Plaza · Houston Pavilions · Eldridge Green Office Building · Houston Baptist University · Weekley YMCA · Lake Houston YMCA · Houston

YEMEN

Public Telecommunication Corporation · Sanaa

Ogni attenzione è stata riservata alla compilazione di questi documenti prima della stampa.

Tuttavia, a causa della continua evoluzione tecnologica ed essendo costantemente impegnati sul fronte dello sviluppo e del miglioramento della nostra gamma di prodotti, ci riserviamo il diritto di modificare senza preavviso le relative specifiche tecniche.

Great care has been taken in the drafting of these document before going to print.

Nonetheless, owing to the continuous technological change and our ongoing commitment to develop and improve our range of products, we reserve the right to develop and improve our range of products and the right to modify the specifications of any product without prior notice.

Une attention particulière a été portée à la production de ces documents avant leur impression.

Cependant, en raison de l'évolution constante des technologies et étant nous-mêmes engagés dans le développement et l'amélioration de notre gamme de produits, nous nous réservons le droit de modifier les spécifications techniques de ceux-ci sans préavis.

Tutti i nostri prodotti sono realizzati in Italia.

All products are entirely made in Italy.

CBI EUROPE Via Mons. A.O. Romero, 14 · 60027 Osimo (AN) Italy
T +39 071 71 08 688 · fax +39 071 71 08 63 · info@cbi-europe.com · www.cbi-europe.com

